

## 1. DESCRIPTION

The BA567E is a panel mounting, general purpose, one input Counter which will function with a wide variety of sensors.

This abbreviated instruction sheet is intended to assist with installation, a comprehensive instruction manual describing system design and configuration may be downloaded from the BEKA website or may be requested from the BEKA sales office.

## 2. INSTALLATION

The BA567E Counter has IP66 front of panel protection but it should be shielded from direct sunlight and severe weather conditions. The rear of the instrument has IP20 protection.

### Cut-out dimensions

Recommended for all installations. Mandatory to achieve IP66 seal between instrument and panel.

90 +0.5/-0.0 x 43.5 +0.5/-0.0

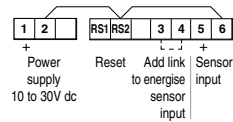
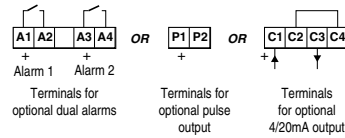
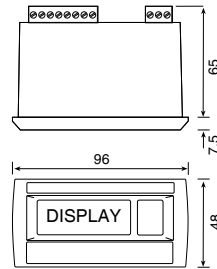

Support panel wiring to prevent vibration damage

Fig 1 Cut-out dimensions and terminals

**Abbreviated instructions for  
BA567E One input general purpose  
panel mounting Counter**

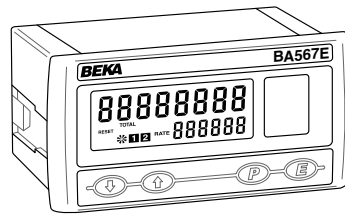

Issue 3  
20th May 2023

**BEKA associates Ltd.** Old Charlton Rd, Hitchin, Hertfordshire,  
SG5 2DA, UK Tel: +44(0)1462 438301 Fax: +44(0)1462 453971  
e-mail: sales@beka.co.uk web: www.beka.co.uk

The BA567E is CE marked to show compliance with the EMC Directive 2014/30/EU. It is also UKCA marked to show compliance with UK Electromagnetic Compatibility Regulations UKSI 2016:1091 (as amended)

1. Align foot and body of panel mounting clamp by turning screw anticlockwise

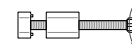

2. Position gasket behind instrument bezel

4. Insert panel clamp into recess and gently pull it onto the dovetail. Engage screw & turn clockwise to tighten the clamp, fit the other clamp(s). Recommended tightening torque 22cNm (1.95lbf.in) Equivalent to finger tight plus one half turn. **DO NOT OVERTIGHTEN**

3. Insert instrument into the panel from the front

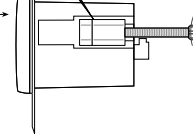

Fig 2 Installation procedure

### EMC

For specified immunity all wiring should be in screened twisted pairs with screens earthed at one point.

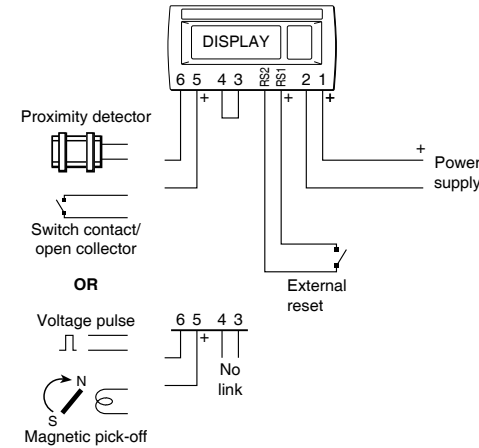

Fig 3 Typical system

### Scale card

The Counters units of measurement are shown on a printed scale card visible through a window at the right hand side of the display. The scale card is mounted on a flexible strip that is inserted into a slot at the rear of the instrument as shown below

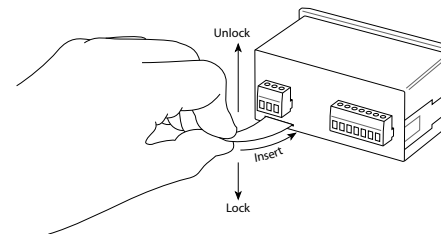
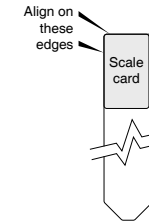

Fig 4 Inserting flexible strip carrying scale card into slot at the rear of Counter.

Thus the scale card can easily be changed without removing the Counter from the panel or opening the instrument enclosure.

New Counters are supplied with a printed scale card showing the requested units of measurement, if this information is not supplied when the Counter is ordered a blank card will be fitted. A pack of self-adhesive scale cards printed with common units of measurement is available as an accessory from BEKA associates. Custom printed scale cards can also be supplied.

To change a scale card, unclip the protruding end of the flexible strip by gently pushing it upwards and pulling it out of the enclosure. Peel the existing scale card from the flexible strip and replace it with a new printed card, which should be aligned as shown below. Do not fit a new scale card on top of an existing card.



Align the self-adhesive printed scale card onto the flexible strip and insert the strip into the Counter as shown.

Fig 5 Fitting scale card to flexible strip

## 3. OPERATION

The Counter is controlled by four front panel push buttons. When in operating mode they have the following functions:

- [P] + [E]** Access to configuration menu.
- [▼] + [▲]** If Local Total Reset [Lr Tot] in the instrument configuration menu has been activated, operating the [▼] and [▲] buttons simultaneously for three seconds will reset the total display to zero and clear any pulses stored in the optional pulse output.
- [E] + [▼]** Grand total - shows Lo followed by least significant 8 digits of the 16 digit grand total.
- [E] + [▲]** Grand total - shows Hi followed by the most significant 8 digits of the 16 digit grand total. If Local Grand Total Reset [Lr Tot] in the instrument configuration menu has been activated, operating the [E] and [▲] buttons simultaneously for ten seconds will result in [Lr.no] being displayed with the no flashing. Operating the [▲] or [▼] button will change the display to [Lr.YE5], the [E] button will then reset the grand total to zero which will be confirmed by a brief display of [Lr.d].
- [P] + [▼]** Shows in succession, firmware version number, instrument function [Func] and any output accessories that are fitted:
  - R Dual Alarm Outputs
  - P Pulse output
  - C 4/20mA output.
- [P] + [▲]** When optional alarms are fitted provides direct access to the alarm setpoints if RSCP (access to setpoints) has been enabled in the configuration menu.

#### 4. CONFIGURATION

Counters are supplied configured as requested at time of ordering, if not specified default configuration will be supplied but can easily be changed on-site.

Fig 6 shows the location of each function within the configuration menu with a brief summary of the function. Please refer to the full instruction manual for detailed configuration information and for description of optional outputs.

Access to the configuration menu is obtained by pressing the **P** and **E** buttons simultaneously. If the Counter's security code is set to default 0000 the first parameter **Input** will be displayed. If the instrument is protected by a security code, **Code** will be displayed. The four digit code must be entered to gain access to the menu.

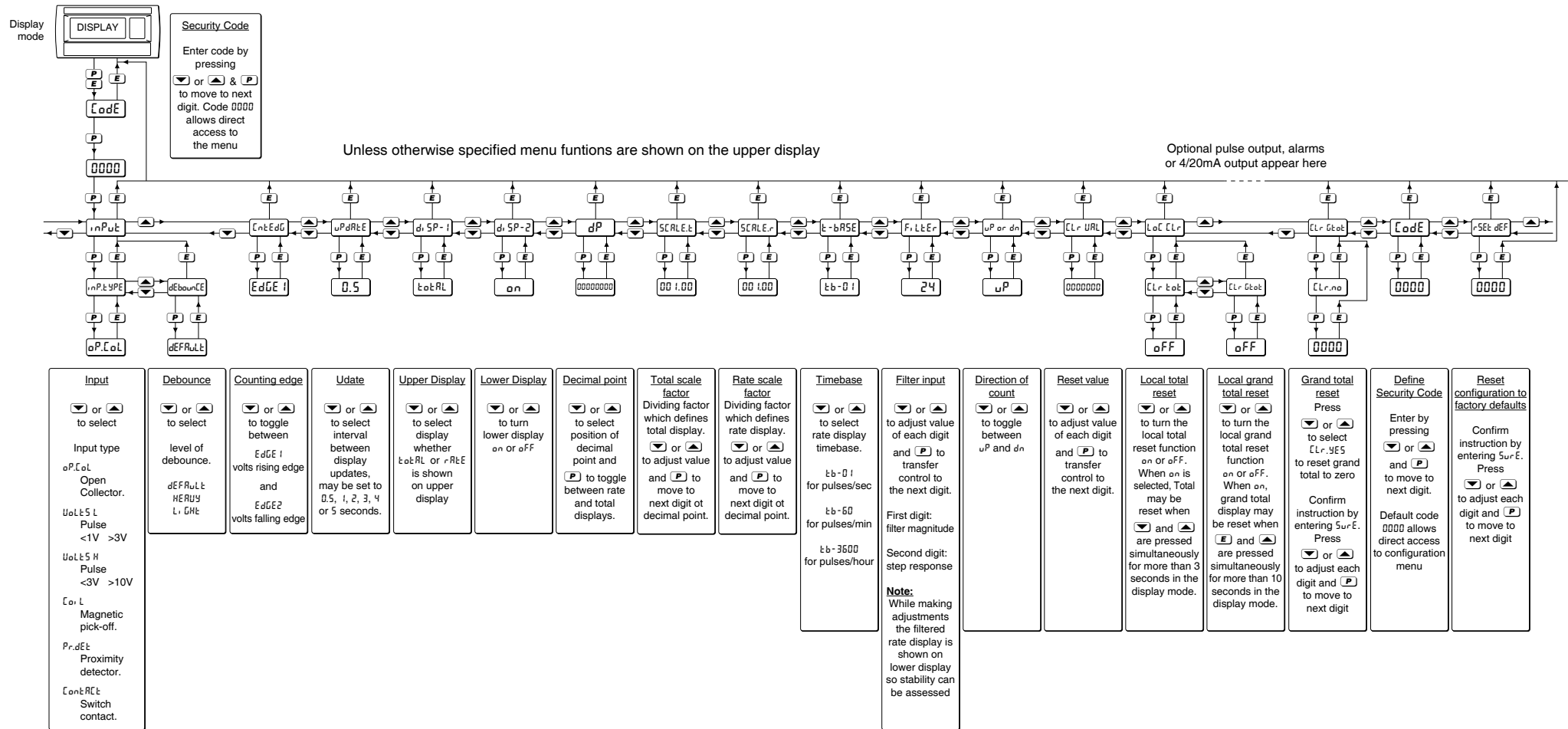

Manuals, certificates and data-sheets can be downloaded from <http://www.beka.co.uk/ba567e>

Fig 6 Configuration menu