

## 1. DESCRIPTION

The BA367NE is an Ex nA & Ex tc, one input Counter housed in a rugged 316 stainless steel panel mounting enclosure which can operate with a wide range of sensors.

This abbreviated instruction sheet is intended to assist with installation, a comprehensive instruction manual describing safety certification, system design and configuration may be downloaded from the BEKA website or may be requested from the BEKA sales office.

The BA367NE has IECEx (IECEx ITS 16.0005X) and ATEX (ITS16ATEX48409X) Ex nA & Ex tc certification for installation in Zone 2 and Zone 22 without the need for Zener barriers or galvanic isolators. ETL and cETL approval permits installation in the USA and Canada. The certification information label, which is located on the top of the instrument enclosure, shows the certification number and codes. Other certifications may be shown. Copies of certificates may be downloaded from the BEKA website.



Typical certification information label

### Special conditions for Ex nA safe use

The ATEX and IECEx certificate numbers have an 'X' suffix indicating that special conditions apply for safe use. These state that the BA367NE Counter should be:

- Mounted such that the instrument terminals are protected by at least an IP54 enclosure certified to IEC 60079-0 or IEC 60079-15 as appropriate.
- Be supplied from limited energy circuits with output parameters in normal operation equal to, or less than the instrument's input parameters.

These special conditions for safe use can be satisfied by mounting the BA367NE in an Ex n, Ex e or Ex p panel enclosure. For ATEX Category 3 installations in Zone 2, self or third party certified Ex n, Ex e or Ex p panel enclosures may be used. Additional requirements apply for non-metallic panel enclosures.

### Ex tc applications in dust atmospheres

See full instruction manual for installation information requirements and special conditions for safe use in combustible dust atmospheres.

## 2. INSTALLATION

### Cut-out dimensions

Mandatory for Ex nA and Ex tc installations and to achieve an IP66 seal between the instrument and the panel.

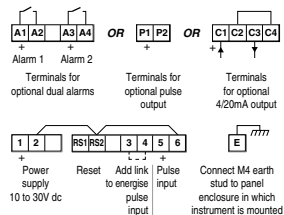
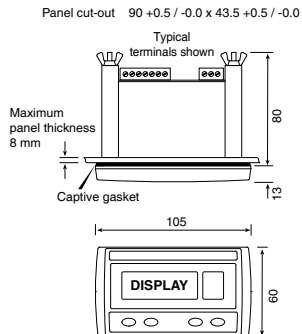

Support panel wiring to prevent vibration damage

Fig 1 Cut-out dimensions and terminals

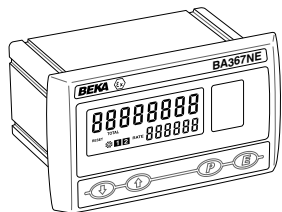
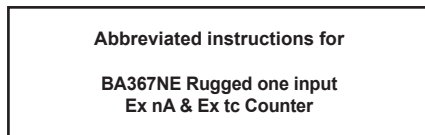

Issue 3  
21st April 2017

BEKA associates Ltd. Old Charlton Rd, Hitchin, Hertfordshire, SG5 2DA, UK  
Tel: +44(0)1462 438301 Fax: +44(0)1462 453971  
e-mail: sales@beka.co.uk web: www.beka.co.uk

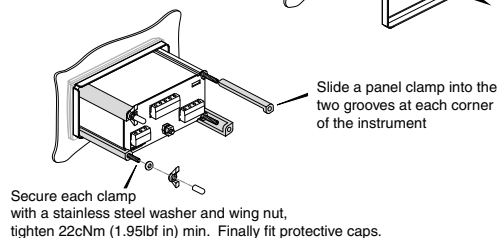
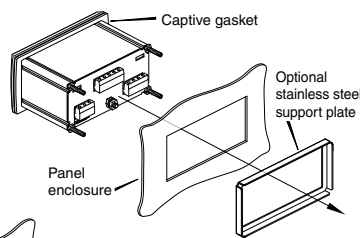

Fig 2 Installation procedure

### EMC

For specified immunity all wiring should be in screened twisted pairs with screens earthed at one point within the safe area.

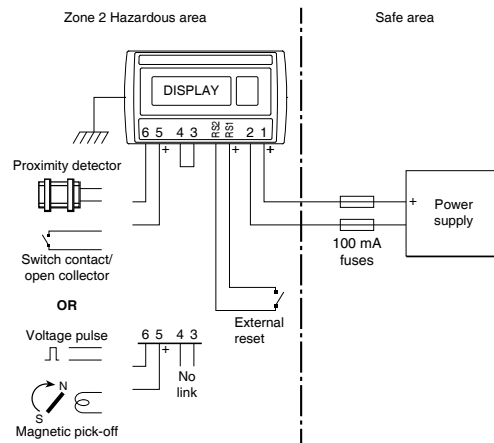

Fig 3 Typical Zone 2 application

### Scale card

The Counter's units of measurement are shown on a printed scale card visible through a window at the right hand side of the display. The scale card is mounted on a flexible strip that is inserted into a slot at the rear of the instrument as shown below

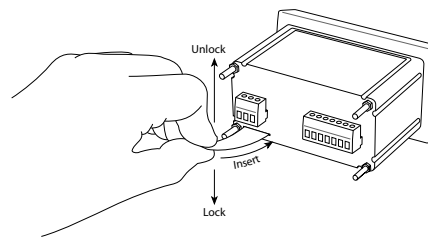

Fig 4 Inserting flexible strip carrying scale card into slot at the rear of Counter.

Thus the scale card can easily be changed without removing the Counter from the panel or opening the instrument enclosure.

New Counters are supplied with a printed scale card showing the requested units of measurement, if this information is not supplied when the Counter is ordered a blank card will be fitted. A pack of self-adhesive scale cards printed with common units of measurement is available as an accessory from BEKA associates. Custom printed scale cards can also be supplied.

To change a scale card, unclip the protruding end of the flexible strip by gently pushing it upwards and pulling it out of the enclosure. Peel the existing scale card from the flexible strip and replace it with a new printed card, which should be aligned as shown below. Do not fit a new scale card on top of an existing card.

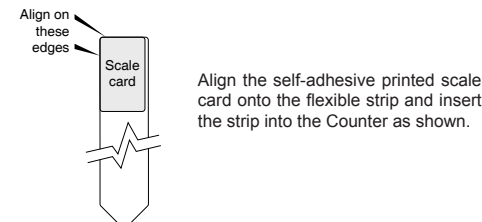

Fig 5 Fitting scale card to flexible strip

## 3. OPERATION

The Counter is controlled by four front panel push buttons. When in the operating mode they have the following functions:

- [P] + [E]** Access to configuration menu.
- [▼] + [▲]** If Local Total Reset [Lr Tot] in the instrument configuration menu has been activated, operating the [▼] and [▲] buttons simultaneously for three seconds will reset the total display to zero and clear any pulses stored in the optional pulse output.
- [E] + [▼]** Grand total - shows Lo followed by least significant 8 digits of the 16 digit grand total.
- [E] + [▲]** Grand total - shows Hi followed by the most significant 8 digits of the 16 digit grand total. If Local Grand Total Reset [Lr Tot] in the instrument configuration menu has been activated, operating the [E] and [▲] buttons simultaneously for ten seconds will result in [Lr.no] being displayed with the no flashing. Operating the [▲] or [▼] button will change the display to [Lr.9E5], the [E] button will then reset the grand total to zero which will be confirmed by a brief display of [Et Lrd].
- [P] + [▼]** Shows in succession, firmware version number, instrument function CountEr and any output accessories that are fitted:
  - R Dual Alarm Outputs
  - P Pulse output
  - C 4/20mA output.
- [P] + [▲]** When optional alarms are fitted provides direct access to the alarm setpoints if R5EP (access setpoints) has been enabled in the configuration menu.

The BA367NE is CE marked to show compliance with the ATEX Directive 2014/34/EU and the EMC Directive 2014/30/EU.

#### 4. CONFIGURATION

Counters are supplied configured as requested at time of ordering, if not specified default configuration will be supplied but can easily be changed on-site.

Fig 6 shows the location of each function within the configuration menu with a brief summary of the function. Please refer to the full instruction manual for detailed configuration information and optional outputs.

Access to the configuration menu is obtained by pressing the **[P]** and **[E]** buttons simultaneously. If the Counter's security code is set to default 0000 the first parameter **Input** will be displayed. If the instrument is protected by a security code, **Code** will be displayed. The four digit code must be entered to gain access to the menu.

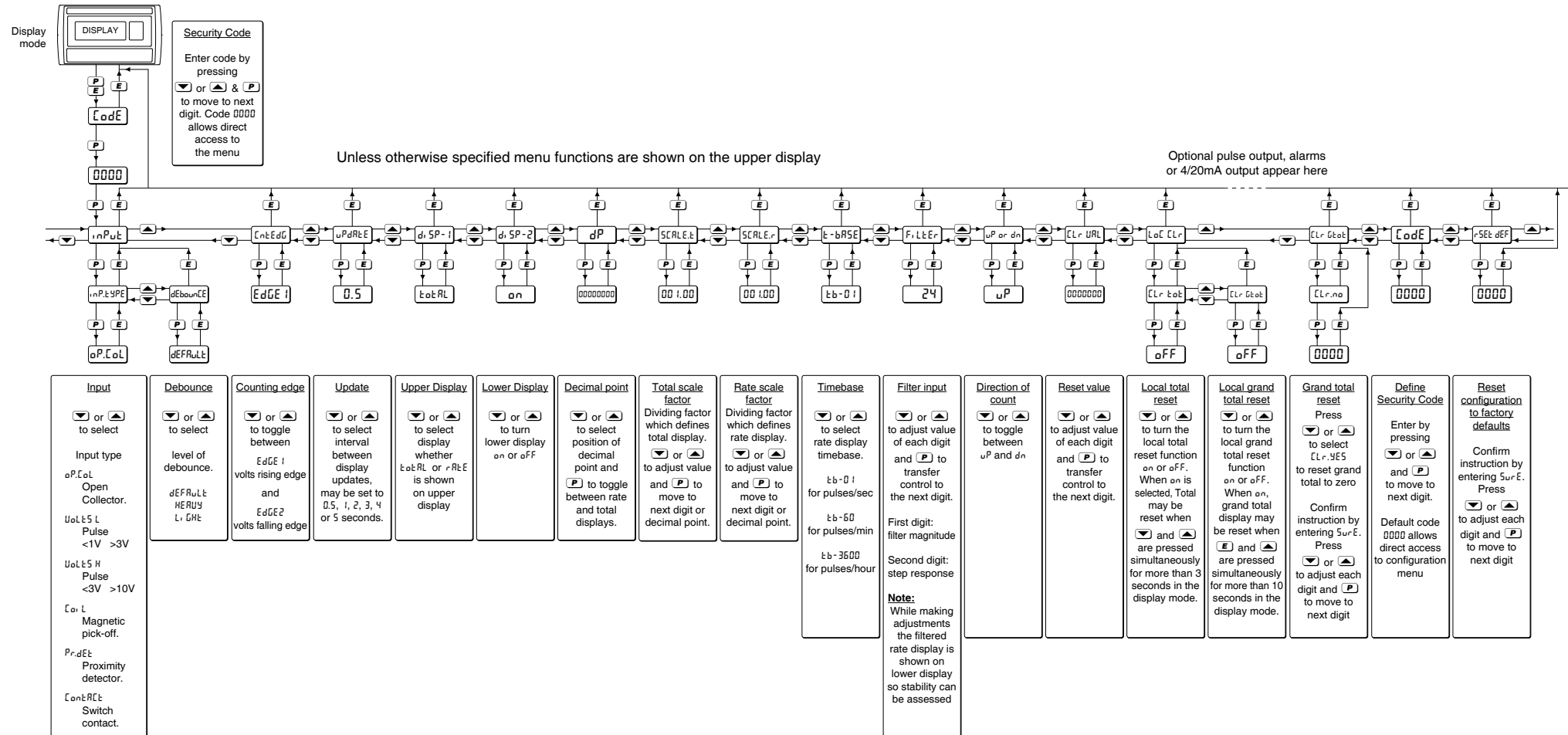

Manuals, certificates and data-sheets can be downloaded from <http://www.beka.co.uk/ba367ne>

Fig 6 Configuration menu