

BA684DF-F
FOUNDATION™ fieldbus
Field mounting
Display
Issue: 10

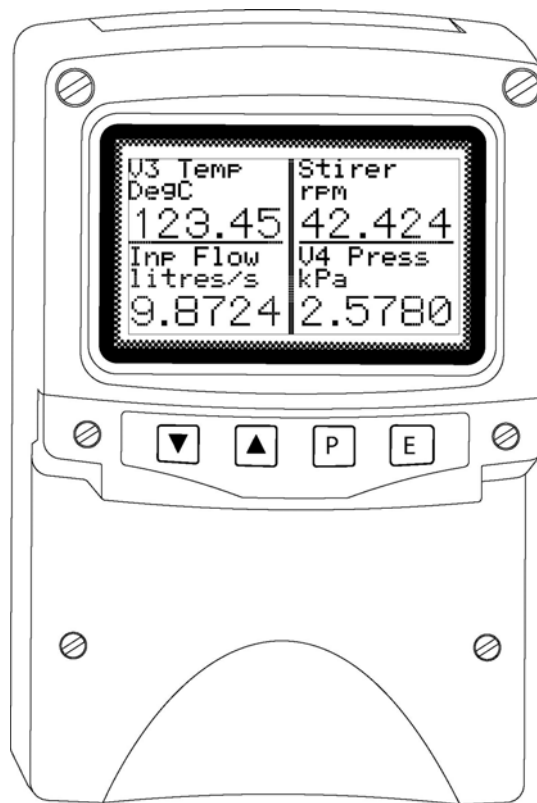

CONTENTS

1. Description

- 1.1 Documentation
- 1.2 Version 2.3 firmware

2. Operation

- 2.1 Controls

3. System Design

- 3.1 External switches
- 3.2 Alarm outputs

4. Installation

- 4.1 Location
- 4.2 Installation procedure
- 4.3 EMC

5. Display & Alarm Configuration

- 5.1 Default configuration
- 5.2 Accessing the display configuration menus
- 5.3 Configurable functions
 - 5.3.1 Screens (Display formats)
 - 5.3.2 Input settings
 - 5.3.3 Tags
 - 5.3.4 Units
 - 5.3.5 Alarms
 - 5.3.5.1 Alarm Summary
 - 5.3.5.2 Alarm Activation
 - 5.3.5.3 Alarm Output
 - 5.3.6 Display
 - 5.3.6.1 Settings
 - 5.3.6.2 Quick Access
 - 5.3.6.3 Access Code
 - 5.3.6.4 Status Text
 - 5.3.6.5 Last Input
 - 5.3.7 Keys
 - 5.3.8 Code
 - 5.3.9 Unit Info
 - 5.3.10 Defaults
 - 5.3.10.1 Display Defaults
 - 5.3.10.2 Interface Board Defaults.
 - 5.3.10.3 FF Revisions 1 and 2
- 5.4 Quick Access Menu

6. Programming

7. Maintenance

- 7.1 Fault finding during commissioning
- 7.2 Fault finding after commissioning
- 7.3 Servicing
- 7.4 Routine maintenance
- 7.5 Guarantee
- 7.6 Customer comments

8. Accessories

- 8.1 Tag plate
- 8.2 Pipe mounting kits
- 8.3 FOUNDATION™ fieldbus Interface Guide.

9. Index

1. DESCRIPTION

The BA684DF-F FOUNDATION™ fieldbus display can display up to eight fieldbus process variables, together with their units of measurement and tag information. The instrument is bus powered so no additional power supply is required.

The instrument's communication protocol is shown on a label inside the terminal cover. The '-F' order number suffix also indicates the protocol but is not shown on the instrument identification label. There is an alternative version of the fieldbus display, order code BA684DF-P for use on Profibus PA networks.

.The BA684DF-F FOUNDATION™ fieldbus display may be ordered, or configured on-site, with alternative function blocks allowing use with most FOUNDATION™ fieldbus hosts.

Revision 1

One Multiple Analogue Output
(1 x MAO)

Revision 2

Two Input Selectors
(2 x IS)

The required Device Description files, which may be downloaded from either the Fieldbus Foundation or the BEKA web sites, depend upon which BA684DF-F FOUNDATION™ fieldbus display revision is selected.

Eleven selectable standard display formats enable one, two, three, four or eight process variables, some with bargraphs to be displayed on one screen.

The BA684DF-F FOUNDATION™ fieldbus display can be supplied with six optional alarm outputs that may be linked to any of the displayed fieldbus variables. These alarm outputs are locally activated from the fieldbus variable and are configured via the instrument menus and push buttons. They can not be controlled via the fieldbus.

Housed in a robust IP66 glass reinforced polyester (GRP) enclosure with a toughened glass window, the BA684DF-F is surface mounting, or may be pipe mounted using one of the accessory kits.

1.1 Documentation

This instruction manual describes system design, conditioning and installation of the BA684DF-F FOUNDATION™ fieldbus display. For detailed commissioning information please refer to the FOUNDATION™ fieldbus Interface Guide that can be downloaded from the BEKA website www.beka.co.uk

1.2 Version 2.3 firmware

This manual describes the enhanced features of BA684DF-F FOUNDATION™ fieldbus displays employing version 2.3 firmware that was released in April 2011 following an interim update to version 2.0 in December 2005.

The new features include:

Standard screens increased to 11

Multiple bargraph limits added

Input scaling added

Selectable function blocks added:

Revision 1

1 x MAO (multiple analogue output)

or Revision 2

2 x IS (Input selector)

Option added to remove status text from single variable screens.

Last variable parameter added to prevent display of unused inputs.

The instrument's firmware version can be established using the 'Unit Info' function in the main configuration menu – see section 5.3.9 of this manual.

BA684DF-F displays employing version 2.3 firmware are backwards compatible with all earlier versions of the instrument.

2. OPERATION

Fig 1 shows a simplified block diagram of the BA684DF-F FOUNDATION™ fieldbus display. When the optional alarms are not fitted, the instrument only requires a two-wire connection to the fieldbus.

How much of the BA684DF-F configuration can be performed via the fieldbus depends upon the instrument version and the system host. Parameters that can not be configured via the fieldbus can be set via the four front panel push buttons. Menus enable the required standard display format to be selected and the units of measurement, plus tag information for each displayed fieldbus variable to be entered. Each fieldbus variable may be individually offset and scaled, and when a standard screen including a bargraph is selected, the limits of each bargraph can be set.

The optional alarms are locally activated from the fieldbus variables and can only be configured and the setpoints adjusted using the BA684DF-F push buttons. The alarms can not be configured or controlled via the fieldbus.

Description files for the BA684DF-F FOUNDATION™ fieldbus display may be downloaded from either the Fieldbus Foundation or from the BEKA associates web sites.

Irrespective of the number of fieldbus variables assigned to the BA684DF-F, the instrument always has provision for displaying eight variables. Unassigned inputs are displayed as zero with a bad data warning i.e. light digits on a dark background. The Last Input parameter allows unused inputs to be skipped when scrolling through the instrument display screens, see section 5.3.6.5.

If enabled, operating the **P** and **▲** push buttons simultaneously activates the Quick Access Menu, allowing the user to adjust the display contrast without providing access to any of the other configuration parameters. Additional security may be provided by an optional access code.

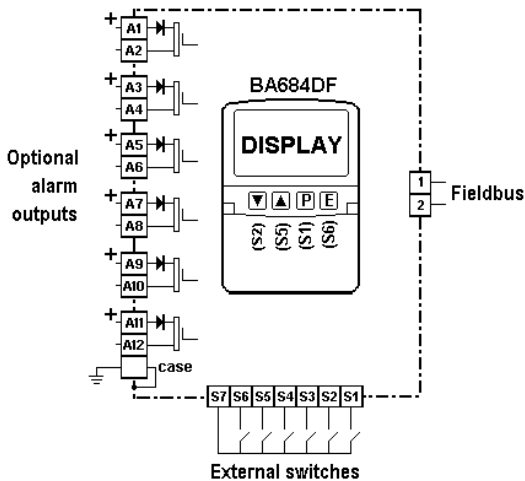

Fig 1 Simplified block diagram of BA684DF-F

2.1 Controls

The user can scroll through the display screens by operating the ▼ or ▲ push buttons. The number of screens available depends upon how the BA684DF-F FOUNDATION™ fieldbus display has been configured. If one fieldbus variable per screen has been configured, eight screens will be present; if four fieldbus variables per screen have been configured, only two screens will be available.

3. SYSTEM DESIGN

The BA684DF-F FOUNDATION™ fieldbus display may be connected to any fieldbus segment as shown in Fig 2, providing it can provide the additional 25mA required to operate the instrument.

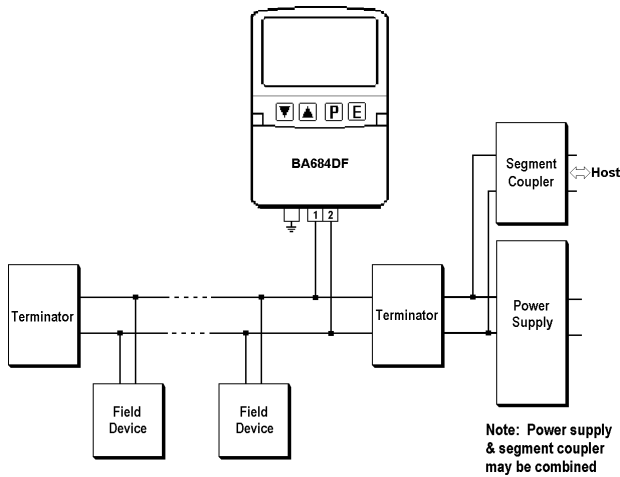

Fig 2 Fieldbus system

3.1 External switches

For applications requiring operator inputs to be made by large industrial push buttons, terminals S1 to S7 allow up to six external switches to be connected to the Fieldbus Display. When external switches are connected, the front panel push buttons may be operated in parallel or disabled – see section 5.3.7.

The BA684DF-F inputs S1 to S7 for external switches are not electrically isolated from the fieldbus terminals, switches and wiring must therefore be isolated from earth and all other electrical circuits.

For reliable operation it is recommended that the cable connecting the Fieldbus Display to the external switches is less than 5m long.

3.2 Alarm outputs

The BA684DF-F can be supplied with six alarm outputs that may be linked to any of the displayed variables. Each alarm output is a galvanically isolated single pole solid state switch output as shown in Fig 3.

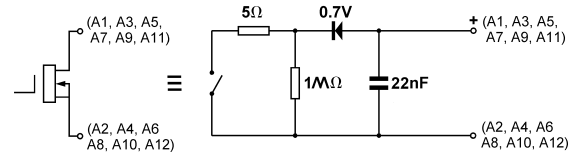

Fig 3 Equivalent circuit of each switch output

The outputs are polarised and current will only flow in one direction. Odd numbered terminals should be connected to the positive side of the supply.

$$\begin{aligned} R_{on} &= 5\Omega + 0.7V \\ R_{off} &= \text{greater than } 1M\Omega \end{aligned}$$

Note: Because of the series protection diode, some test meters may not detect a closed alarm output.

WARNING

These Alarm Outputs should not be used for critical safety applications such as an emergency shut down system.

When the BA684DF-F FOUNDATION™ fieldbus display is disconnected from the fieldbus, or the fieldbus is de-energised, all the alarm outputs will open irrespective of how they have been configured.

4. INSTALLATION

4.1 Location

The BA684DF-F FOUNDATION™ fieldbus display is housed in a robust IP66 glass reinforced polyester (GRP) enclosure incorporating an armoured glass window and stainless steel fittings. It is suitable for exterior mounting in most industrial environments, including off-shore and waste water treatment installations. Please consult BEKA associates if high vibration is anticipated.

The BA684DF-F enclosure is surface mounting. Accessory kits described in sections 8.2 of this manual enable the instrument to be mounted onto a vertical or horizontal pipe.

The field terminals and the two mounting holes are located in a separate compartment with a sealed cover allowing the instrument to be installed without exposing the display assembly.

The BA684DF-F earth terminal is connected to the carbon loaded GRP case. If the case is not bolted to a post or structure connected to the plant potential equalising conductor, the instrument's earth terminal should be connected to the potential equalising conductor.

The BA684DF-F enclosure is supplied with a bonding plate to ensure electrical continuity between the three conduit / cable entries.

4.2 Installation Procedure

Fig 4 illustrates the instrument installation procedure.

- a. Remove the instrument terminal cover by unscrewing the two captive 'A' screws.
- b. Mount the instrument on a flat surface and secure with two M6 screws through the 'B' holes. Alternatively use one of the mounting kits described in section 8.2
- c. Remove the temporary hole plug and install an appropriate IP rated cable gland or conduit fitting. If more than one entry is required, one or both of the IP66 stopping plugs may be replaced with an appropriate IP rated cable gland or conduit fitting.
- d. Connect the field wiring to the terminals as shown in Fig 5.
- e. Replace the instrument terminal cover and evenly tighten the two 'A' screws.

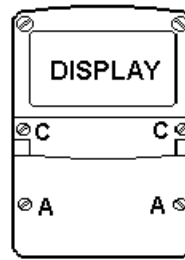

Step a

Remove the terminal cover by unscrewing the two 'A' screws

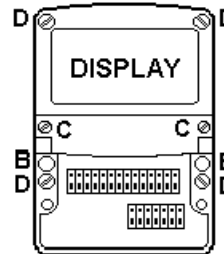

Step b

Secure the instrument to a flat surface with M6 screws through the two 'B' holes. Alternatively use a pipe mounting kit.

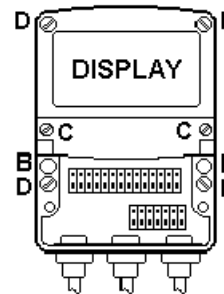

Steps C and D

Remove the temporary hole plug and install an appropriate IP rated cable gland or conduit fitting. If more than one entry is required, one or both of the IP66 stopping plugs may be

replaced with an appropriate IP rated cable gland or conduit fitting. Finally replace the terminal cover and tighten the two 'A' screws.

Fig 4 BA684DF-F installation procedure

4.3 EMC

The BA684DF-F complies with the requirements of the European EMC Directive 2004/108/EC. For specified immunity, all wiring should be in screened twisted pairs with the screens connected to the plant's potential equalising conductor.

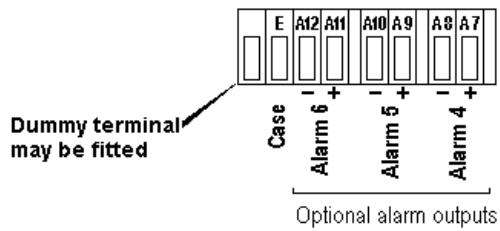
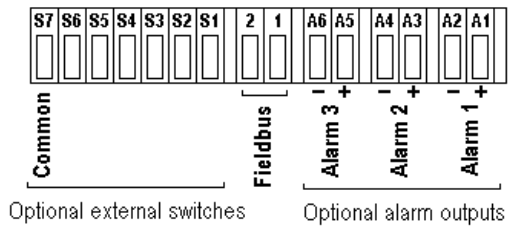
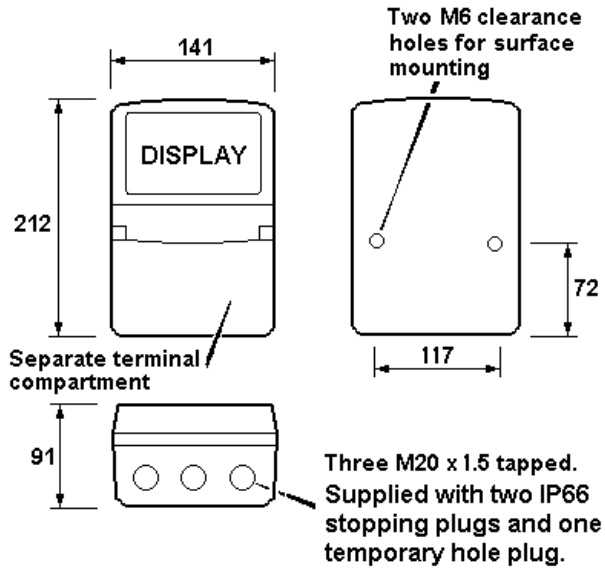

Fig 5 Dimensions and terminal connections

5. DISPLAY & ALARM CONFIGURATION

In addition to loading the BA684DF-F FOUNDATION™ fieldbus display Device Description files onto the system host and defining up to eight fieldbus variables that are to be displayed, the instrument display and alarms, if fitted, have to be configured. How much of this configuration can be done via the fieldbus depends upon the instrument version and the system host. Parameters that can not be configured via the fieldbus, should be configured via the four front panel push buttons and the easy to use menu shown in Fig 6. The optional alarms can only be configured via the instrument push buttons.

When navigating through the configuration menu, the push button(s) should be held until the required screen is displayed.

5.1 Default configuration

Unless otherwise requested at the time of ordering, BA684DF-F Fieldbus Displays will be supplied configured as follows:

Keys	Both
Display brightness	100%
Display contrast	50%
Quick access menu	On
Quick access menu code	0000
Configuration menu access code.	0000
Screen	Single variable
Number format	Auto
All alarms	Disabled
Alarm activation	Good data only
Alarm outputs	N/C
Bargraph	
Low	0
High	100
Input scaling	
Zero offset	0
Gain factor	1
Status text	On
Lat input	8
Revision	Revision 2 (2 x IS function blocks)

5.2 Accessing the display configuration menus

Throughout this manual push buttons are shown in italics e.g. *P* or ▲ push button, and legends displayed by the instrument are shown within inverted commas e.g. 'Enter Access Code'.

Operating the *P* and *E* push buttons simultaneously accesses the display configuration menu. If the BA684DF-F is not protected by an access code the main menu will be displayed. If an access code other than the default code 0000 has already been entered, the BA684DF-F will request that the access code be entered.

Using the ▼ or ▲ button set the first digit of the code which will be flashing. Pressing *P* will transfer control to the next digit, which should be adjusted in the same way. When all four digits have been set, pressing the *E* button will enter the access code. If the code is correct the main menu will be displayed, if the code is incorrect 'Invalid Code' will be displayed.

When entering an access code, timeout will occur and the instrument will automatically return to the operating mode ten seconds after a push button was last operated. In all other menus, timeout occurs after sixty seconds.

The structure of the display configuration menu is shown in Fig 6. Navigation is achieved by highlighting the required function using the ▼ and ▲ buttons and then operating the *P* button to display the selected function sub-menu, from which a further selection or adjustment may be made. Operating the *E* button moves the display back up one level.

A flashing highlight indicates that an option or alphanumeric character may be selected using the ▼ and ▲ buttons and entered using the *E* button. If only one entry or adjustment can be made in a sub-menu, the display will automatically move up one menu level when the adjustment is entered. If more than one adjustment can be made in a sub-menu, the highlight may be moved to the second variable using the ▼ or ▲ button after the first setting has been entered. Operating the *P* button allows the second variable to be adjusted.

When multiple numeric or alpha characters are adjusted e.g. an alarm setpoint or a tag legend, the adjustment is made one digit at a time using the ▼ and ▲ buttons. After the first flashing digit has been set as required, the flashing highlight can be moved to the next digit by operating the *P* button. When all digits have been set, operating the *E* button will enter the setting.

Following completion of the instrument configuration, the *E* button should be operated to step the display back to the main menu. One more operation of the *E* button will then return the BA684DF-F to the operating mode.

5.3 Configurable functions

This section provides an explanation of each configurable function and should be read in conjunction with Fig 6.

5.3.1 Screens (Display format)

The BA684DF-F FOUNDATION™ fieldbus display can display up to eight fieldbus variables that are identified as IN_1 to IN_8. The fieldbus variable that each one represents is determined by the BA684DF-F configuration at the fieldbus system host - see the *FOUNDATION fieldbys™ Interface Guide*.

This sub-menu allows one of eleven standard display formats containing one, two, three, four or eight fieldbus variables some with bargraphs as shown below.

The 'Text Display' option which enabled custom formats to be created is depreciated i.e. still available but no longer actively supported.

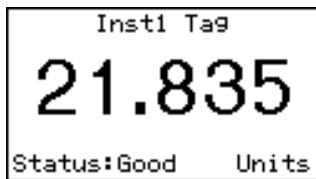

One variable

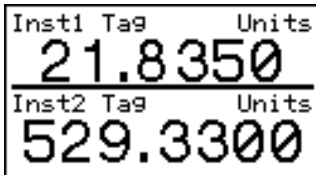

Two variables

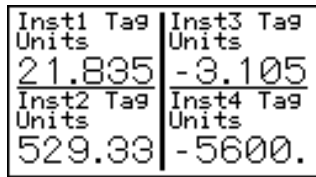

Four variables

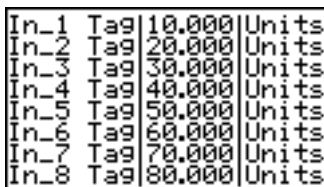

Eight variables



One variable + horizontal bargraph

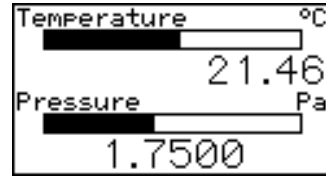

Two variables + horizontal bargraphs

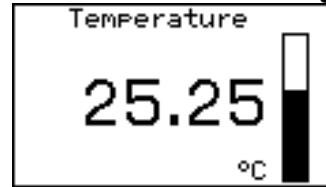

One variable + vertical bargraph

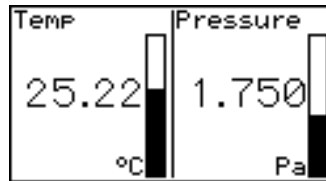

Two variables + vertical bargraphs

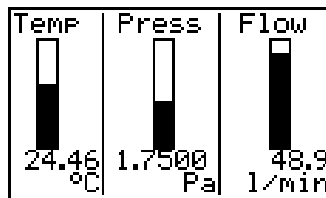

Three variables + vertical bargraphs

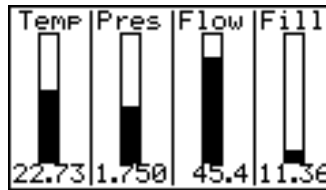

Four variables + vertical bargraphs

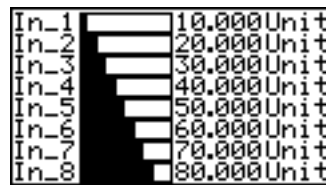

Eight variables + horizontal bargraphs

5.3.2 Input Settings

Note: Only included in Revision 1 instruments. Omitted from Revision 2 instruments because these parameter can be easily configured in the Display Transducer Block.

The Input Setting function is divided into two groups of sub-functions. The first, 'BarLimits Src' is included to maintain backwards compatible with earlier firmware issues in which fieldbus variables IN_7 and IN_8 were used to define all the bargraph limits. This reduced the number of fieldbus variables that could be displayed with bargraphs from eight to six.

Version 2.3 firmware includes the improved 'Per Input' option that enables the lower and upper limits of a bargraph for each of the eight fieldbus variables to be defined via the front panel push buttons. It is recommended that 'Per Input' option be used for new installations.

In addition to defining individual limits for up to eight bargraphs, the second group of sub-functions enables the decimal point position for each display to be defined. Each of the eight fieldbus inputs may also be offset and scaled before being displayed which allows variables to be displayed in alternative units of measurement.

$$\text{Display} = (\text{Gain} \times \text{Fieldbus variable}) + \text{Offset}$$

The sub-functions for each input are:

'Offset' Adds a positive or negative offset to the fieldbus variable before it is displayed.

'Gain' Multiplies the fieldbus variable by a factor before it is displayed.

'Bar Lo' Defines the bargraph lower limit

'Bar Hi' Defines the bargraph higher limit

'Format' Defines the position of the displayed decimal point.

Six options are available:

Auto: Max resolution with selected display format.

4 DP 4 digits on right of decimal point

3 DP 3 digits on right of decimal point

2 DP 2 digits on right of decimal point

1 DP 1 digit on right of decimal point

0 DP No decimal point

The total number of display digits available depends upon the display screen selected – see 5.3.1

Standard Screen	Description	Digits
1	1 variable	5, 7, 11 or 17*
2	2 variables	7
3	4 variables	5
4	8 variables	5
5	1 variable + H bar	5, 7, 11 or 17*
6	2 variables + H bars	7
7	1 variable + V bar	6
8	2 variables +V bars	4
9	3 variables + V bars	6
10	4 variables + V bars	4
11	8 variables + H bars	5

* Font automatically resizes in auto mode

If a negative number is likely to be displayed, a digit must be allocated for the negative sign. If the display overranges all the digits will display '?'.
For all options leading zeros, apart from the zero in front of a decimal place, are automatically suppressed.

For all options leading zeros, apart from the zero in front of a decimal place, are automatically suppressed.

5.3.3 Tags

Note: Only included in Revision 1 instruments. Omitted from Revision 2 instruments because tags can be easily defined in the Display Transducer Block.

Each of the eight fieldbus variables may be displayed with an individual tag that can contain up to sixteen alphanumeric characters. This menu allows these tags to be entered. After selecting the required variable, the tag legend is entered character by character using the ▼ and ▲ push-buttons. Numbers, upper & lower case letters and symbols are available.

5.3.4 Units

Note: Only included in Revision 1 instruments. Omitted from Revision 2 instruments because units of measurement can be easily defined in the Display Transducer Block.

Each of the eight fieldbus variables may be displayed with units of measurement that can contain up to eight alphanumeric characters. This menu allows these units of measurement to be entered. After selecting the required variable, the unit of measurement is entered character by character using the ▼ and ▲ push-buttons. Numbers, upper & lower case letters and symbols are available.

5.3.5 Alarms

Note: *Alarm menus are only included when the BA684DF-F is fitted with optional alarm outputs. Outputs are locally activated from the fieldbus variables and are configured via the instrument menus and push buttons. They can not be controlled via the fieldbus.*

Each of the six alarms may be linked to any one of the eight fieldbus variables displayed by the BA684DF-F. Each alarm output can be conditioned to function as a high or a low alarm, or as a combined high and low alarm. The output can be conditioned as normally open 'N/O' or normally closed 'N/C' in the non-alarm condition. Irrespective of settings, all alarm outputs will be open when the instrument is not powered from the fieldbus.

When an alarm is activated, the associated fieldbus variable display flashes, i.e. alternates between dark figures on a light background and light figures on a dark background.

There are eight alarm-conditioning sub-menus.

5.3.5.1 Alarm Summary

Shows to which fieldbus variable each alarm is linked and how each alarm has been conditioned. i.e. high, low, or combined high & low alarm with a normally open or closed output. No adjustments can be made via this sub-menu.

5.3.5.2 Alarm Activation

Fieldbus variables that have not been validated are displayed with dark characters on a light background, and some screen formats also contain a status indication. This sub-menu allows the alarm outputs to be conditioned so that they only operate with validated fieldbus data, or to operate irrespective of data validity.

5.3.5.3 Alarm Output

There is a separate sub-menu for each of the six alarm outputs; these link the alarm to one of the displayed fieldbus variables and define the alarm function and the setpoints.

To link the alarm to a displayed variable, position the highlight over the 'IN_n' field, press **P** and using the ▼ or ▲ button select the required input source. Enter the selection by pressing the **E** button.

Each alarm output can be N/O or N/C in the non-alarm condition. To change the setting, position the highlight over the 'N/O' or 'N/C' field, press **P** and use the ▼ or ▲ button to toggle the setting. Enter the selection by pressing the **E** button.

Each alarm output has three functions that can be independently enabled to condition the output as a low or high alarm, or as a combined low and high alarm, either with or without hysteresis.

The required functions can be individually enabled by positioning the highlight over the Enb/Dis (Enabled/Disabled) column, pressing **P** and toggling the function to the required state, then entering the selection by pressing the **E** button.

Alarm setpoints are entered digit by digit. Place the highlight over the setpoint to be adjusted and press **P**; the flashing digit to be adjusted may then be selected by again pressing **P**. When all the digits have been adjusted, operating the **E** button enters the value and moves the menu up one level.

The function of all alarms may be reviewed from the alarm summary menu - see 5.3.5.1.

5.3.6 Display

5.3.6.1 Settings

The backlight brilliance and display contrast are adjustable from this sub-menu.

5.3.6.2 Quick Access

This sub-menu enables the Quick Access Menu which is described in sections 2.1 and 5.4. When enabled, an operator can adjust the display contrast and backlight brilliance without having access to any other conditioning menus.

5.3.6.3 Access Code

Defines a four digit alphanumeric code that must be entered to gain access to the Quick Access Menu. Alpha characters are case sensitive. Default code 0000 allows direct access without a code.

5.3.6.4 Status Text

The two single variable screens 1 and 4 will show the status of the FOUNDATION™ fieldbus variable as 'Good' or 'Bad' if the Status Text function is activated.

5.3.6.5 Last Input

This function allows the maximum number of FOUNDATION™ fieldbus variables to be defined so that unused inputs are skipped when the display is scrolled in the operating mode.

5.3.7 Keys

The function of the front panel push buttons may be transferred to four of the six optional external push buttons, with or without disabling the BA684DF-F front panel push buttons. The table below shows the function of the BA684DF-F front panel and the external push buttons for each of the four options that may be selected in the Keys sub-menu.

Selected option from Keys sub-menu	Push buttons	Function of push buttons		
		Screen scrolling	P+E access to configuration menu	P+Up access to quick access menu
Internal	BA684DF-F	Yes	Yes	Yes
	External	No	No	No
External	BA684DF-F	No	Yes	No
	External	Yes	Yes	Yes
Both	BA684DF-F	Yes	Yes	Yes
	External	Yes	Yes	Yes
Internal + Port	BA684DF-F	Yes	Yes	Yes
	External	No	No	No

For applications where the instrument is only displaying 1, 2, 3, 4 or 8 variables on a single screen, it is recommended that external buttons are selected but not fitted. This will disable the instrument front panel buttons, but still provide access to the configuration menu, which may be protected by a security code.

5.3.8 Code

Defines the four digit alphanumeric code that must be entered to gain access to the instrument configuration menus. Alpha characters are case sensitive. Default code 0000 allows direct access without a code.

5.3.9 Unit Info

Displays the instrument model number and the software version.

5.3.10 Defaults

This function enables the display and interface board factory defaults to be restored. The function blocks (Revision 1 or 2) should be selected to suit the system host.

5.3.10.1 Display Defaults

This function restores the display defaults defined in section 5.1.

CAUTION

Existing settings can not be recovered after this function has been used.

5.3.10.2 Interface Board Defaults

This function restores the Fieldbus Interface Board factory defaults.

CAUTION

Do not use this function when the BA684DF-F is connected to an operational fieldbus, as communication will be terminated.

5.3.10.3 Revisions 1 and 2

Unless specified at the time of ordering, BA684DF-F- FOUNDATION™ fieldbus displays will be supplied as Revision 2 instruments. i.e. two input selector function blocks (2 x IS).

The BA684DF-F can be converted to a Revision 1 instrument using the Default menu. i.e one multiple analogue output function block (1 x MAO).

The BA684DF-F FOUNDATION™ fieldbus display revision should be chosen so that the fieldbus function blocks selected are supported by the system host.

To change the BA684DF-F revision, highlight the required revision in the 'Restore Defaults' menu and follow the screen prompts until 'Defaults Loaded Now power cycle the unit' is displayed. To complete the installation remove the BA684DF-F power supply for a few seconds, when power is restored the instrument will restart with the selected revision.

5.4 Quick Access Menu

The Quick Access Menu allows an operator to adjust the backlight brilliance and the display contrast without having access to the other configuration parameters.

The quick access menu is accessed by operating the **P** and **▲** push buttons simultaneously. If the Quick Access Menu is not protected by an access code the contrast and brilliance controls will be displayed immediately. If an access code other than the default code 0000 has already been entered, the BA684DF-F will request that the access code be entered.

The display backlight brilliance is adjusted using the **▼** and **▲** push buttons. Operating the **P** push button will transfer control to the display contrast adjustment. When both are set as required, operating the **E** button will store both settings and return the instrument to the operating mode.

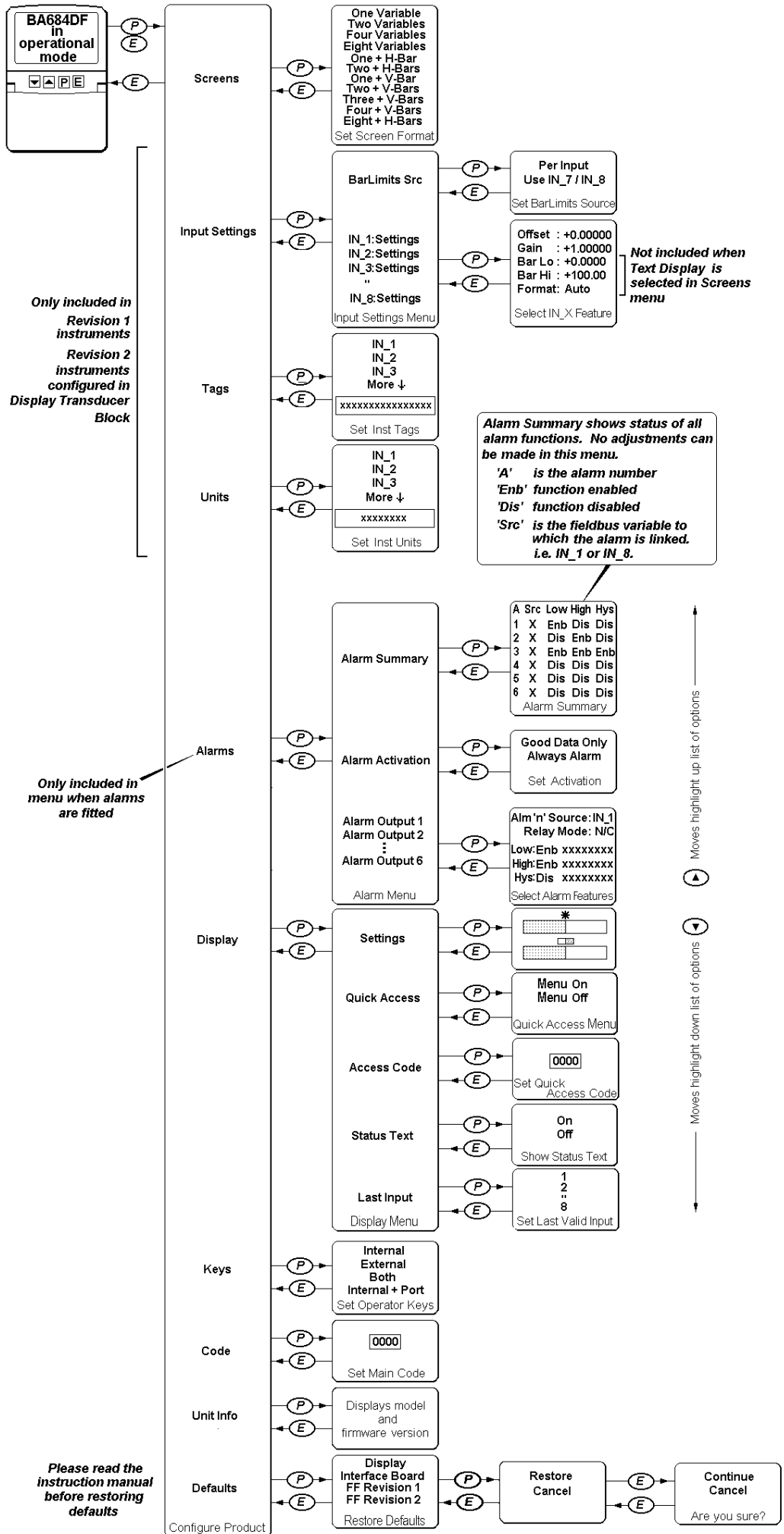

Fig 7 Structure of Configuration Menu

6. PROGRAMMING

The 'Text Display' option which enabled custom formats to be created is depreciated i.e. still available but no longer actively supported.

7. MAINTENANCE

7.1 Fault finding during commissioning

If a BA684DF-F FOUNDATION™ fieldbus display fails to function during commissioning the following procedure should be followed:

Symptom	Cause	Check:
No Display	Fieldbus not powered	9 to 32V between terminals 1 & 2.
No variables	Fieldbus not configured BA684DF-F does not have correct protocol	Instrument configuration at host That BA684DF-F protocol is same as fieldbus. i.e. Fieldbus Foundation or Profibus PA.
Wrong variable displayed	Wrong screen selected	Other screens by operating <i>Up</i> or <i>Down</i> button
Display showing '????'	Display overrange	Number format see section 5.3.2
No backlight	Brilliance turned down	Setting in display menu
Low or excessive contrast	Incorrect contrast setting	Setting in display menu
Displayed variable is inverted i.e. light digits on dark background	Variable has 'bad' status	Configuration and instrument supplying variable
Displayed variable is flashing	Associated alarm has been activated	Setpoints
Bargraph on standard display format is shown dotted	Displayed fieldbus variable is outside bargraph limits or data is 'bad'	Bargraph limits see section 5.3.5

7.2 Fault finding after commissioning

ENSURE PLANT SAFETY BEFORE STARTING MAINTENANCE

If a BA684DF-F fails after it has been functioning correctly, the table shown in section 7.1 may help to identify the cause of the failure.

If this procedure does not reveal the cause of the fault, it is recommended that the instrument is replaced.

7.3 Servicing

We recommend that faulty BA684DF-F FOUNDATION™ fieldbus display are returned to BEKA associates or to our local agent for repair.

7.4 Routine maintenance

The mechanical and electrical condition of the instrument should be regularly checked. Initially annual inspections are recommended, although the inspection frequency should be adjusted to suit the environmental conditions.

7.5 Guarantee

Instruments which fail within the guarantee period should be returned to BEKA associates or our local agent. It is helpful if a brief description of the fault symptoms is provided.

7.6 Customer comments

BEKA associates is always pleased to receive comments from customers about our products and services. All communications are acknowledged and whenever possible, suggestions are implemented.

8. ACCESSORIES

8.1 Tag plate

The BA684DF-F can be supplied with a blank or custom engraved stainless steel plate secured by two screws to the front of the instrument enclosure. This plate can accommodate:

1 row of 9 alphanumeric characters 10mm high

or 1 row of 11 alphanumeric characters 7mm high

or 2 rows of 18 alphanumeric characters 5mm high

8.2 Pipe mounting kits

Two pipe mounting kits are available for securing the BA684DF-F to a horizontal or vertical pipe.

BA392D Stainless steel bracket secured by two worm drive hose clips for 60 to 80mm outside diameter pipes.

BA393 Heavy duty stainless steel bracket secured by a single 'V' bolt. Will clamp to any pipe with an outside diameter between 40 and 80mm.

8.3 FOUNDATION™ fieldbus Interface Guide

The BEKA FOUNDATION™ fieldbus Interface Guide which may be downloaded from the BEKA website at www.beka.co.uk contains configuration information for all BEKA FOUNDATION™ fieldbus products.

9. INDEX

Subject	Section	Subject	Section
Alarms	5.3.5	Pipe mounting kits	8.2
Activation	5.3.5.2	Profibus PA	1
Output	3.2; 5.3.5.3		
Summary	5.3.5.1	Quick access menu	5.3.6.2; 5.4
Backlight	5.3.6.1	Revisions 1 & 2	5.3.10.3
Bargraph limits	5.3.2	Servicing	7.3
Configuration menu	Fig 6	Screens (display format)	5.3.1
Controls	2.1	Status Text	5.3.6.4
Code	5.3.8		
Decimal points	5.3.2	Tags	5.3.3
Default settings	5.1; 5.3.10	Tag plate	8.1
Display	5.3.6	Terminal numbers	Fig 5
Access code	5.3.6.3		
Settings	5.3.6.1	Units (of measurement)	5.3.4
Quick access	5.3.6.2	Unit Info (firmware version)	5.3.9
EMC	4.3		
External switches	3.1; 5.3.7		
Fault finding			
During commissioning	7.1		
After commissioning	7.2		
Guarantee	7.5		
Input scaling	5.3.2		
Installation	4.		
Interface Guides	8.4		
Keys	5.3.7		
Last Input	5.3.6.5		
Location	4.1		
Maintenance	7.		
Routine	7.4		
Number Format	5.3.2		