

BA614DF-F
FOUNDATION™ fieldbus
Field mounting
Fieldbus Indicator
Issue: 4

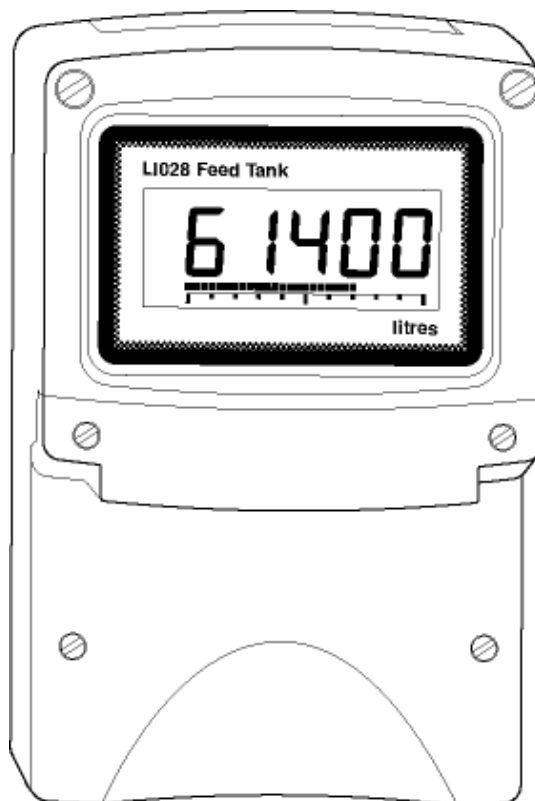

CONTENTS

1. Description

- 1.1 Documentation

2. System Design

3. Installation

- 3.1 Location
- 3.2 Installation procedure
- 3.3 EMC

4. Maintenance

- 4.1 Fault finding during commissioning
- 4.2 Fault finding after commissioning
- 4.3 Servicing
- 4.4 Routine maintenance
- 4.5 Guarantee
- 4.6 Customer comments

5. Accessories

- 5.1 Scale and Tag marking
- 5.2 Tag plate
- 5.3 Pipe mounting kits
- 5.4 Fieldbus Interface Guide

1. DESCRIPTION

The BA614DF-F Fieldbus Indicator is a FOUNDATION™ fieldbus instrument compliant with ITC 6.3 that can display one fieldbus process variable on a five digit LCD and 31 segment analogue bargraph. The instrument is bus powered so no additional power supply is required.

Communication Protocol	Fieldbus Function Block
FOUNDATION™ fieldbus	Input Selector (1 x IS)

The Device Description files may be downloaded from the FieldComm or the BEKA associates web sites.

Housed in a robust IP66 glass reinforced polyester (GRP) enclosure with a toughened glass window, the BA614DF-F is surface mounting, or may be pipe mounted using one of the accessory kits.

1.1 Documentation

This instruction manual describes system design and installation of the BA614DF-F Fieldbus Indicator. For commissioning information please refer to:

FOUNDATION™ fieldbus
Fieldbus Interface Guide
for
Fieldbus Displays and
Fieldbus Indicators

which can be downloaded from the BEKA website at www.beka.co.uk

The instrument's communication protocol is shown on a label inside the terminal cover. The '-F' order code suffix also indicates the protocol but is not shown on the instrument identification label.

2. SYSTEM DESIGN

The BA614DF-F Indicator is powered and communicates via the fieldbus which is connected to non-polarised terminals 1 and 2. As shown in Fig 1 the instrument may be connected to any fieldbus segment which can supply the additional 13mA required to power the instrument.

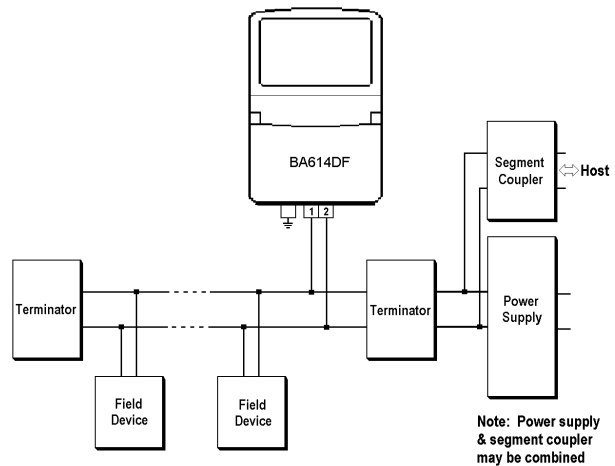

Fig 1 Fieldbus system

3. INSTALLATION

3.1 Location

The BA614DF-F Fieldbus Indicator is housed in a robust IP66 glass reinforced polyester (GRP) enclosure incorporating a toughened glass window and stainless steel fittings. It is suitable for exterior mounting in most industrial environments, including offshore and waste water treatment installations. Please consult BEKA associates if high vibration is anticipated.

The BA614DF-F enclosure is surface mounting. Accessory kits described in sections 5.3 of this manual enable the instrument to be mounted onto a vertical or horizontal pipe.

The field terminals and the two enclosure mounting holes are located in a separate compartment with a sealed cover allowing the instrument to be installed without exposing the display assembly.

The BA614DF-F earth terminal is connected to the carbon loaded GRP enclosure. If this enclosure is not bolted to an earthed post or structure, the earth terminal should be connected to a local earth.

The BA614DF-F enclosure is supplied with a bonding plate to ensure electrical continuity between the three conduit / cable entries.

3.2 Installation Procedure

Fig 2 illustrates the instrument installation procedure.

- a. Remove the instrument terminal cover by unscrewing the two captive 'A' screws.
- b. Mount the instrument on a flat surface and secure with two M6 screws through the 'B' holes. Alternatively use one of the mounting kits described in section 5.3
- c. Remove the temporary hole plug and install a cable gland or conduit entry with required ingress protection. If more than one entry is required, replace one or both IP66 stopping plugs with a cable gland or conduit entry having the required ingress protection.
- d. Connect the field wiring to the terminals as shown in Fig 3.
- e. Replace the instrument terminal cover and evenly tighten the two 'A' screws.

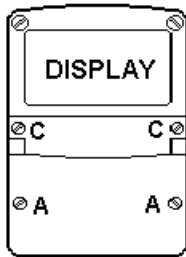

Step a
Remove the terminal cover by unscrewing the two 'A' screws

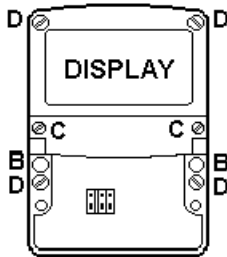

Step b
Secure the instrument to a flat surface with M6 screws through the two 'B' holes. Alternatively use a pipe mounting kit.

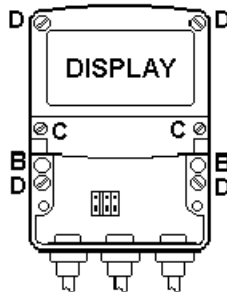

Steps c, d and e
Remove temporary hole plug and install cable gland or conduit fitting with required ingress protection. If more than one entry is required, one or two of the IP66 stopping plugs should be replaced with a cable gland or conduit

fitting with required ingress protection. Replace the terminal cover and tighten the two 'A' screws.

Fig 2 BA614DF-F installation procedure

3.3 EMC

The BA614DF-F complies with the requirements of the European EMC Directive 2014/30/EU. For specified immunity, all wiring should be in screened twisted pairs with the screens earthed at one point.

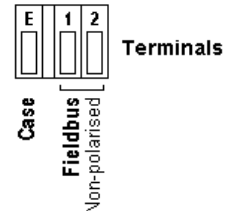
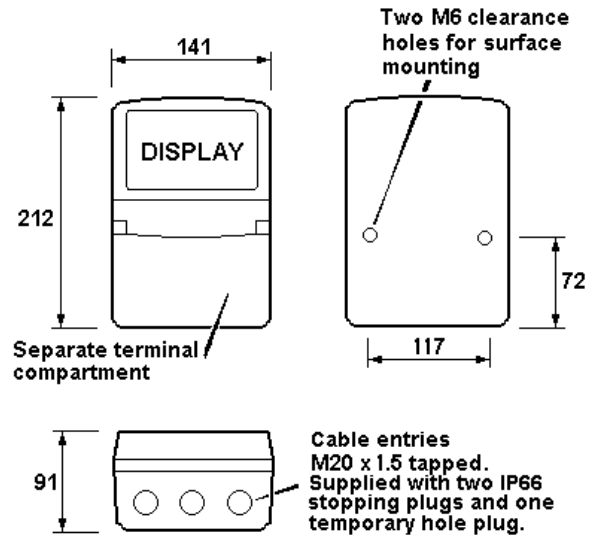

Fig 3 Dimensions and terminal connections

4. MAINTENANCE

4.1 Fault finding during commissioning

If a BA614DF-F fails to function during commissioning the following procedure should be followed:

Symptom	Cause	Check:
No Display	Instrument not correctly connected or powered.	9 to 32V between terminals 1 & 2.
Display shows '9.9.9.9.9' with all decimal points flashing; all bargraph segments activated and bargraph scale flashing.	Value over-range	Variable source Decimal point configuration.
Display shows '-9.9.9.9.9' with all decimal points flashing; no bargraph segments activated and bargraph scale flashing.	Value under-range	Variable source Decimal point configuration
Display alternates between value and the word 'bAd'. Bargraph flashes.	Status of fieldbus variable has a quality of 'BAD' or a fault state is active. Display has not yet received data.	Variable source Fieldbus configuration.
Bargraph scale flashes.	Variable is outside the limits defined for the bargraph.	Bargraph configuration.
All display segments activated.	Display is initialising.	This is normal operation, after a few seconds the firmware version will be displayed prior to entering the operational mode.

4.2 Fault finding after commissioning

ENSURE PLANT SAFETY BEFORE STARTING MAINTENANCE

If a BA614DF-F fails after it has been functioning correctly, the table shown in section 4.1 may help to identify the cause of the failure.

If this procedure does not reveal the cause of the fault, it is recommended that the instrument is replaced.

4.3 Servicing

We recommend that faulty BA614DF-F Fieldbus Indicators are returned to BEKA associates or to our local agent for repair.

4.4 Routine maintenance

The mechanical and electrical condition of the instrument should be regularly checked. The frequency of inspections depends upon the environmental conditions.

4.5 Guarantee

Instruments which fail within the guarantee period should be returned to BEKA associates or our local agent. It is helpful if a brief description of the fault symptoms is provided.

4.6 Customer comments

BEKA associates is always pleased to receive comments from customers about our products and services. All communications are acknowledged and whenever possible, suggestions are implemented.

5. ACCESSORIES

5.1 Scale and tag marking

BA614DF-F indicators are fitted with a blank escutcheon around the liquid crystal display. If specified when the instrument is ordered, this can be supplied printed with units of measurement and tag information. Alternatively, information may be added on-site via an embossed strip, dry transfer or a permanent marker.

To gain access to the display escutcheon remove the terminal cover by unscrewing the two 'A' screws which will reveal two concealed 'D' screws. Unscrew all four 'D' screws and carefully lift off the front of the instrument. The location of all these screws is shown in Fig 2.

After adding the required legends, or fitting a new pre-printed self-adhesive escutcheon, ensure that the gasket is correctly positioned before reassembling the instrument enclosure.

5.2 Tag plate

The BA614DF-F can be supplied with a blank or custom laser marked stainless steel plate secured by two screws to the front of the instrument enclosure. This plate can accommodate:

1 row of 9 alphanumeric characters 10mm high

or 1 row of 11 alphanumeric characters 7mm high

or 2 rows of 18 alphanumeric characters 5mm high

5.3 Pipe mounting kits

Two pipe mounting kits are available for securing the BA614DF-F to a horizontal or vertical pipe.

BA392D Stainless steel bracket secured by two worm drive hose clips for 60 to 80mm outside diameter pipes.

BA393 Heavy-duty stainless steel bracket secured by a single 'V' bolt. Will clamp to any pipe with an outside diameter between 40 and 80mm.

5.4 Fieldbus Interface Guide

The *FOUNDATION™ fieldbus Interface Guide for Fieldbus Displays & Fieldbus Indicators* contains commissioning information for the BA614DF-F. A copy may be requested from the BEKA sales office or downloaded from the BEKA website at www.beka.co.uk