

**BA484DF-P
PROFIBUS PA
Intrinsically safe
Field mounting
Fieldbus Display**

Issue: 5

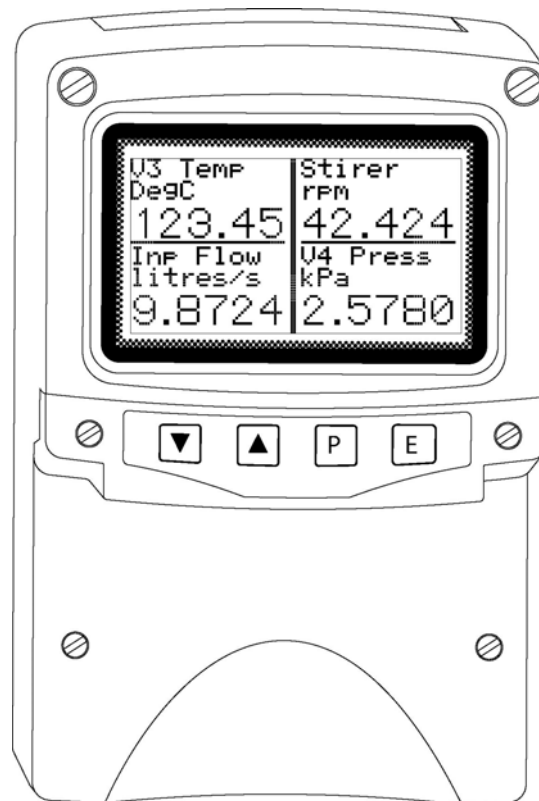

CONTENTS

1. Description

- 1.1 Documentation
- 1.2 Version 2.0 firmware

2. Operation

- 2.1 Controls

3. Intrinsic Safety Certification

- 3.1 ATEX certificate
- 3.2 Zones, gas groups and T rating
- 3.3 Fieldbus connection
- 3.4 External switches
- 3.5 Alarm outputs
- 3.6 Certification label information

4. System Design for Hazardous Area

- 4.1 FISCO Systems
- 4.2 Non-FISCO Systems
- 4.3 External switches
- 4.4 Alarm outputs

5. Installation

- 5.1 Location
- 5.2 Installation procedure
- 5.3 EMC

6. Display & Alarm Configuration

- 6.1 Default configuration
- 6.2 Accessing the display configuration menus
- 6.3 Configurable functions
 - 6.3.1 Screens (Display format)
 - 6.3.2 Input Settings
 - 6.3.3 Tags
 - 6.3.4 Units
 - 6.3.5 Alarms
 - 6.3.5.1 Alarm Summary
 - 6.3.5.2 Alarm Activation
 - 6.3.5.3 Alarm Output
 - 6.3.6 Display
 - 6.3.6.1 Settings
 - 6.3.6.2 Quick Access
 - 6.3.6.3 Access Code
 - 6.3.6.4 Status Text
 - 6.3.6.5 Last input
 - 6.3.7 Keys
 - 6.3.8 Code
 - 6.3.9 Unit Info
 - 6.3.10 Defaults
 - 6.3.10.1 Display Defaults
 - 6.3.10.2 Interface Board Default
 - 6.3.11 Instrument address
- 6.4 Quick Access Menu

7. Maintenance

- 7.1 Fault finding during commissioning
- 7.2 Fault finding after commissioning
- 7.3 Servicing
- 7.4 Routine maintenance
- 7.5 Guarantee
- 7.6 Customer comments

8. Accessories

- 8.1 Tag plate
- 8.2 Pipe mounting kits
- 8.3 Fieldbus Display Programming Guide.
- 8.4 Fieldbus Interface Guides

9. Index

Appendix 1

ATEX dust certification

Appendix 2

FM Approval for use in the USA

Appendix 3

IECEx certification

The BA484DF-P PROFIBUS display is CE marked to show compliance with the European Explosive Atmospheres Directive 94/9/EC and the European EMC Directive 2004/108/EC

1. DESCRIPTION

The BA484DF-P PROFIBUS Display is an intrinsically safe instrument that can simultaneously display up to eight PROFIBUS PA process variables, together with their units of measurement and tag information. The instrument is bus powered so no additional power supply is required.

Order Code	Communication Protocol	Function Blocks
BA484DF-P	PROFIBUS PA	Eight Analogue outputs (8 x AO) Six Digital inputs (6 x DI)

The instrument's communications protocol is shown on a label inside the terminal cover. The '-P' order code suffix also indicates the protocol but is not shown on the instrument certification label. There is an alternative version of the fieldbus display, order code BA484DF-F for use on FOUNDATION™ fieldbus systems.

Configuration may be performed by either a DPV 0 user PRM data download, or by a DPV 1 configurator and if required the instrument address may be entered via the instrument's front panel push buttons. The required GSD files are available for downloading from both the PROFIBUS and BEKA websites.

Eleven selectable standard display formats enable one, two, three, four or eight process variables, some with bargraphs to be displayed simultaneously on one screen.

The four front panel push buttons that control the instrument display may also be used for returning operator acknowledgements, thus enabling the BA484DF-P PROFIBUS Display to function as a simple operator interface. If larger industrial push buttons are required for entering these acknowledgements, up to six external switches may be connected to the BA484DF-P. These switch inputs may also be used for returning the status of plant contacts to the host using the DI function blocks.

The BA484DF-P PROFIBUS Display can be supplied with six optional alarm outputs that may be linked to any of the displayed fieldbus variables. These alarm outputs are locally activated from the fieldbus variables and are configured via the instrument menus and push buttons. They can not be controlled via the fieldbus.

The instrument has been issued with an EC-Type Examination Certificate by Notified Body Intertek Testing and Certification Ltd for gas and dust atmospheres which has been used to confirm compliance with the European Potentially Explosive Atmospheres Directive 94/9/EC.

For use in the USA the instrument has intrinsic safety and nonincendive FM Approval – see Appendix 2, plus IECEx intrinsic safety approval for international applications – see Appendix 3.

Housed in a robust IP66 glass reinforced polyester (GRP) enclosure with a toughened glass window, the BA484DF-P is surface mounting, or may be pipe mounted using one of the accessory kits.

1.1 Documentation

This instruction manual describes system design, conditioning and installation of the BA484DF-P PROFIBUS display. For detailed commissioning information please refer to the PROFIBUS Interface Guide that can be downloaded from the BEKA website www.beka.co.uk

1.2 Version 3.0 firmware

This manual describes BA484DF-P PROFIBUS displays employing version 3.0 firmware that was released in July 2010 and is not backwards compatible with earlier versions.

Version 3.0 firmware provides

- Addition of (6 x DI) function blocks to return switch status to host.

- Fieldbus address entry via instrument push buttons.

- Addition of DPV 0 configuration

- Addition of two standard screens allowing eight fieldbus variables to be simultaneously displayed.

- Removal of text display facilities

- When using the ▼ or ▲ button to select input, or groups of inputs to be displayed, unused inputs can now be skipped.

The instrument's firmware version can be established using the 'Unit Info' function in the main configuration menu – see section 6.3.9 of this manual. Version 3.0 firmware is shown as SW480F-02-300.

For BA484DF-P PROFIBUS displays employing version 2.0 firmware, please refer to the BA484DF-P Intrinsically safe field mounting fieldbus display Issue 10 manual dated 8th May 2006 which may be downloaded from the obsolete products section of the BEKA website.

2. OPERATION

Fig 1 shows a simplified block diagram of the BA484DF-P PROFIBUS display. When the optional alarms and external switches are not used, the instrument only requires a two-wire connection to the fieldbus.

How much of the BA484DF-P PROFIBUS Display configuration can be performed via the fieldbus depends upon the system host. Parameters that can not be configured via the fieldbus can be set using the configuration menu shown in Fig 7 and the four front panel push buttons.

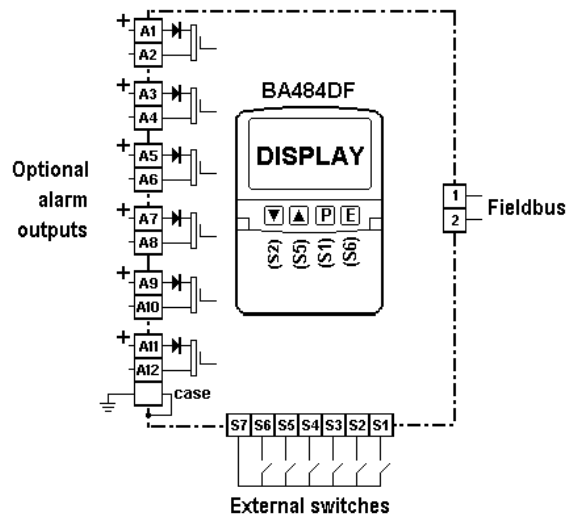

Fig 1 Simplified block diagram of BA484DF-P

2.1 Controls

The user can scroll through the display screens by operating the ▼ or ▲ push buttons. The number of screens available depends upon how the BA484DF-P PROFIBUS display has been configured and the number of process variables that are to be displayed. If one fieldbus variable per screen has been configured and eight variables are to be displayed, eight screens will be present; if two fieldbus variables per screen have been configured and six variables are to be displayed, three screens will be available.

If enabled, operating the **P** and ▲ push-buttons simultaneously activates the Quick Access Menu, allowing the user to adjust the display contrast without providing access to any of the other configuration parameters. Additional security may be provided by an optional access code.

3. INTRINSIC SAFETY CERTIFICATION

3.1 ATEX certificate

The BA484DF-P PROFIBUS display has been issued with an EC-Type Examination Certificate by Notified Body Intertek Testing and Certification (ITS) which has been used to confirm compliance with the European ATEX Directive 94/9/EC for gas and dust atmospheres. The instrument bears the Community Mark and, subject to local codes of practice, may be installed in any of the European Economic Area (EEA) member countries. ATEX certificates are also acceptable for installations in Switzerland.

This manual describes installations in explosive gas atmospheres which conform with IEC 60079-14 Electrical installations design, selection and erection. When designing systems for installation outside the UK, the local Code of Practice should be consulted.

For use in the presence of combustible dust, please refer to Appendix 1.

3.2 Zones, gas groups and T rating

The BA484DF-P PROFIBUS display has been issued with EC Type Examination certificate ITS04ATEX22778 confirming that it complies with the requirements for Group II Category 1 G Ex ia IIC T4 Ga (Tamb –40 to 60°C). When connected to a suitable certified system the BA484DF-P may be installed in:

- | | |
|--------|---|
| Zone 0 | explosive gas air mixture continuously present. |
| Zone 1 | explosive gas air mixture likely to occur in normal operation. |
| Zone 2 | explosive gas air mixture not likely to occur, and if it does will only exist for a short time. |

Be used with gases in groups:

- Group A propane
- Group B ethylene
- Group C hydrogen

Having a temperature classification of:

- T1 450°C
- T2 300°C
- T3 200°C
- T4 135°C

At an ambient temperature between –40 and +60°C.

Note: the guaranteed operating temperature range of the Fieldbus Display is –20 to +60°C

This allows the BA484DF-P PROFIBUS display to be installed in all Zones and to be used with most common industrial gases.

3.3 Fieldbus connection

The BA484DF-P PROFIBUS display is powered and communicates via the fieldbus, which is connected to terminals 1 and 2. These terminals comply with the Fieldbus Intrinsically Safe Concept (FISCO) defined in IEC 60079:11, which simplifies intrinsic safety system design.

The BA484DF-P may also be connected to non-FISCO compliant fieldbus segments by using the entity concept to assess safety.

Terminals 1 and 2 of the BA484DF-P Fieldbus Display are not polarised and have the following safety parameters:

$$\begin{aligned} U_i &= 17.5V \text{ dc} \\ I_i &= 380mA \text{ dc} \\ P_i &= 5.32W \end{aligned}$$

For non-FISCO compliant segments, the safety parameters of the power supply or isolator powering the fieldbus segment must be equal to or less than these figures.

The maximum equivalent capacitance and inductance at terminals 1 & 2 of the BA484DF-P Fieldbus Display is:

$$\begin{aligned} C_i &= 1nF \\ L_i &= 8\mu H \end{aligned}$$

To determine cable parameters for non-FISCO compliant segments, the sum of C_i and L_i of all the field devices should be subtracted from the maximum cable parameters permitted by the device powering the fieldbus segment.

3.4 External switches

For applications requiring operator inputs to be made by large industrial push buttons, terminals S1 to S7 facilitate external switches to be connected to the Fieldbus Display. When external switches are connected, the BA484DF-P PROFIBUS Display may be configured so that the front panel push buttons continue to function or are disabled.

Terminals S1 to S7 have the following combined output safety parameters:

$$\begin{aligned} U_o &= 14.7V \text{ dc} \\ I_o &= 146.7mA \text{ dc} \\ P_o &= 0.58W \end{aligned}$$

The switches and associated wiring connected to the terminals must comply with the requirements for *simple apparatus*. i.e. the switch must be mechanically activated and have IP20 protection, and both the switch and the wiring must be capable of withstanding a 500V rms insulation test to earth for one minute. Most industrial push buttons and wiring satisfy these requirements.

The input safety parameters of terminals S1 to S7 are zero, therefore only mechanically activated switches or intrinsically safe relays may be connected.

The total maximum permitted cable parameters for all the cables connected to terminals S1 to S7 in a IIC hydrogen gas must be less than:

$$\begin{aligned} C_o &= 0.22\mu F \\ L_o &= 0.26mH \end{aligned}$$

Although these parameters are not restrictive, for reliable operation it is recommended that the cables between the fieldbus display and the external switch is less than 5m long.

3.5 Alarm outputs

Each of the six optional alarm outputs is a separate galvanically isolated, solid state, single pole switch. The EC-Type Examination Certificate specifies that under fault conditions the voltage, current and power at each switch output will not exceed those specified for *simple apparatus* in section 5.7 of EN 60079-11. This allows each of the BA484DF-P alarm outputs to be connected to any intrinsically safe circuit protected by a certified Zener barrier or galvanic isolator providing that the output parameters of each circuit are less than:

$$\begin{aligned} U_o &= 28V \text{ dc} \\ I_o &= 200mA \\ P_o &= 0.84W \end{aligned}$$

The maximum equivalent capacitance and inductance of each BA484DF-P alarm output is:

$$\begin{aligned} C_i &= 40nF \\ L_i &= 20\mu H \end{aligned}$$

To determine the maximum permissible cable parameters, C_i and L_i must be subtracted from the maximum cable capacitance and inductance specified by the certificate of the circuit connected to the alarm output.

3.6 Certification Label Information

The certification label is fitted in a recess on the top outer surface of the enclosure. It shows the ATEX certification information, a statement that the instrument is a FISCO Field Device, plus BEKA associates name and location. Non-European certification information may also be included. The instrument serial number and year of manufacture are recorded on a separate label inside the terminal compartment.

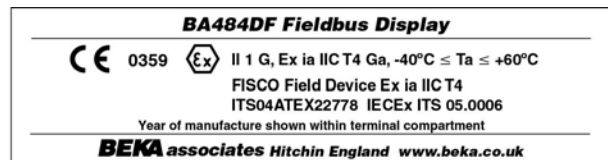

4. SYSTEM DESIGN FOR HAZARDOUS AREAS

4.1 FISCO Systems

The BA484DF-P PROFIBUS display may be connected to any FISCO compliant fieldbus segment, providing the segment can provide the additional 25mA required to operate the PROFIBUS Display.

Fig 2 shows a typical fieldbus segment. To comply with FISCO requirements, the power supply, terminators, field devices and the interconnecting cables must conform with IEC 60079:11.

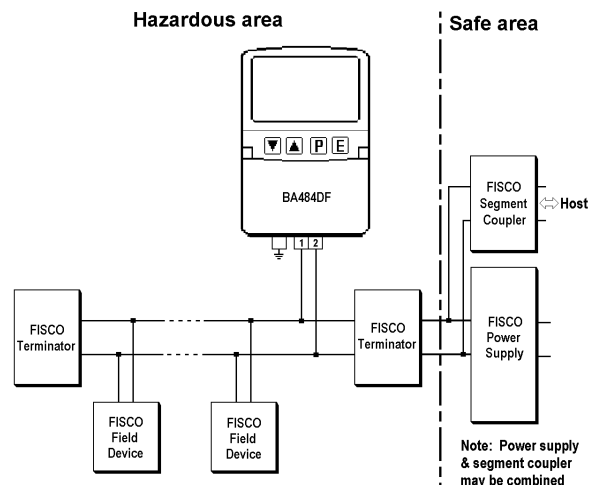

Fig 2 FISCO fieldbus system

4.2 Non-FISCO Systems

If the BA484DF-P PROFIBUS display is to be connected to a fieldbus segment that does not comply with FISCO requirements, the safety parameters of the power supply and the PROFIBUS Display should be compared using the entity concept.

The maximum output safety parameters of the device powering the fieldbus segment must be equal to, or less than, the input safety parameters of terminals 1 & 2 of the BA484DF-P PROFIBUS Display, namely:

$$\begin{aligned} U_i &= 17.5V \text{ dc} \\ I_i &= 380mA \text{ dc} \\ P_i &= 5.32W \end{aligned}$$

The maximum permitted cable parameters for the fieldbus segment must be reduced by the equivalent internal capacitance C_i and inductance L_i of the BA484DF-P. The BA484DF-P equivalent capacitance and inductance are very small and make little practical difference.

$$\begin{aligned} C_i &= 1nF \\ L_i &= 8\mu H \end{aligned}$$

4.3 External switches

For applications requiring operator inputs to be made by large industrial push buttons, terminals S1 to S7 allow up to six external switches to be connected to the Fieldbus Display. When external switches are connected, the front panel push buttons may be operated in parallel or disabled – see section 6.3.7

For installation in a hazardous area the switches and associated wiring must comply with the requirements for *simple apparatus*. i.e. the switch must be mechanically activated and have IP20 protection, and both the switch and the wiring must be capable of withstanding a 500V rms insulation test to earth for one minute. Most industrial push buttons and wiring satisfy these requirements.

Although the allowable cable parameters are large, it is recommended that the cables are less than 5m long.

If a safe area switch is to be connected to a BA484DF-P PROFIBUS display located in a hazardous area, the switch contact must be transferred via a certified intrinsically safe relay or a galvanic isolator having zero output safety parameters as shown in Fig 3.

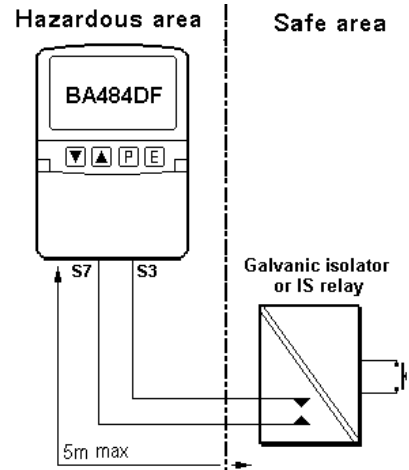

Fig 3 External push-button switch in safe area

4.4 Alarm outputs

Each alarm output is a galvanically isolated single pole solid state switch output as shown in Fig 4.

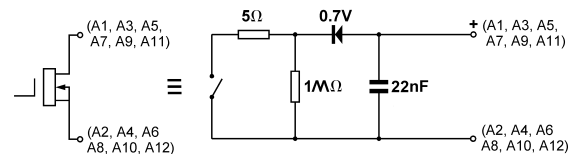

Fig 4 Equivalent circuit of each switch output

The outputs are polarised and current will only flow in one direction. Odd numbered terminals should be connected to the positive side of the supply.

$$\begin{aligned} R_{on} &= 5\Omega + 0.7V \\ R_{off} &= \text{greater than } 1M\Omega \end{aligned}$$

Note: Because of the series protection diode, some test meters may not detect a closed alarm output.

WARNING

These Alarm Outputs should not be used for critical safety applications such as an emergency shut down system.

When the BA484DF-P is disconnected from the fieldbus, or the fieldbus is de-energised, all the alarm outputs will open irrespective of how they have been configured.

5. INSTALLATION

5.1 Location

The BA484DF-P PROFIBUS display is housed in a robust IP66 glass reinforced polyester (GRP) enclosure incorporating an armoured glass window and stainless steel fittings. It is suitable for exterior mounting in most industrial environments, including off-shore and waste water treatment installations. Please consult BEKA associates if high vibration is anticipated.

The BA484DF-P enclosure is surface mounting. Accessory kits described in sections 8.2 of this manual enable the instrument to be mounted onto a vertical or horizontal pipe.

The field terminals and the two mounting holes are located in a separate compartment with a sealed cover allowing the instrument to be installed without exposing the display assembly.

The BA484DF-P earth terminal is connected to the carbon loaded GRP case. If the case is not bolted to a post or structure connected to the plant potential equalising network, the instrument's earth terminal should be connected to the potential equalising network as recommended in EN 60079-14.

The BA484DF-P enclosure is supplied with a bonding plate to ensure electrical continuity between the three conduit / cable entries.

5.2 Installation Procedure

Fig 5 illustrates the instrument installation procedure.

- a. Remove the instrument terminal cover by unscrewing the two captive 'A' screws.
- b. Mount the instrument on a flat surface and secure with two M6 screws through the 'B' holes. Alternatively use one of the mounting kits described in section 8.2
- c. Remove the temporary hole plug and install an appropriate IP rated cable gland or conduit fitting. If more than one entry is required, one or both of the IP66 stopping plugs may be replaced with an appropriate IP rated cable gland or conduit fitting.
- d. Connect the field wiring to the terminals as shown in Fig 6.
- e. Replace the instrument terminal cover and evenly tighten the two 'A' screws.

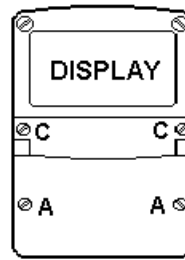

Step a

Remove the terminal cover by unscrewing the two 'A' screws

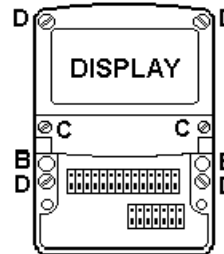

Step b

Secure the instrument to a flat surface with M6 screws through the two 'B' holes. Alternatively use a pipe mounting kit.

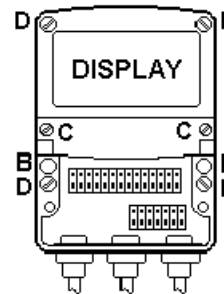

Steps C and D

Remove the temporary hole plug and install an appropriate IP rated cable gland or conduit fitting. If more than one entry is required, one or both of the IP66 stopping plugs may be

replaced with an appropriate IP rated cable gland or conduit fitting. Finally replace the terminal cover and tighten the two 'A' screws.

Fig 5 BA484DF-P installation procedure

5.3 EMC

The BA484DF-P complies with the requirements of the European EMC Directive 2004/108/EC. For specified immunity, all wiring should be in screened twisted pairs with the screens connected to the potential equalising network as recommended in EN 60079-14.

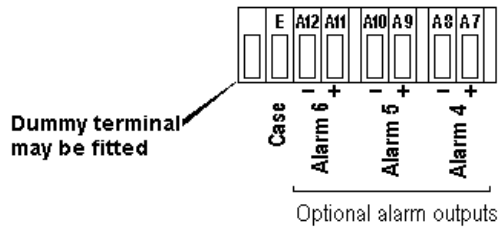
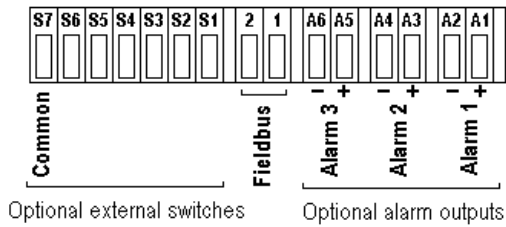
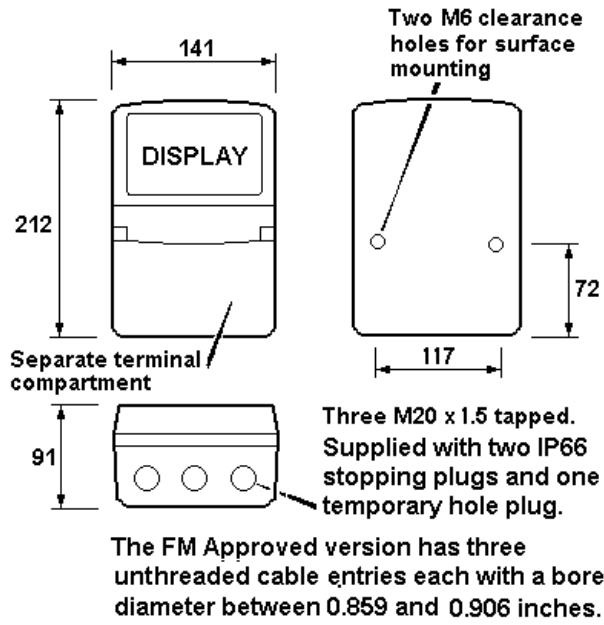

Fig 6 Dimensions and terminal connections

6. DISPLAY & ALARM CONFIGURATION

In addition to loading the BA484DF-P PROFIBUS display GSD files onto the system host and defining up to eight fieldbus variables that are to be displayed, the instrument address, display and alarms, if fitted, have to be configured. How much of this configuration can be performed via the fieldbus depends upon the system host. Parameters that can not be configured via the fieldbus, may be set via the four front panel push buttons.

All the display and alarm configuration functions are contained in an easy to use menu that is shown in Fig 7. Where necessary the sub-menus contain on-screen prompts to guide the user through each adjustment.

When navigating through the configuration menu, the push-button(s) should be held until the required screen is displayed.

6.1 Default configuration

Unless otherwise requested at the time of ordering, BA484DF-P PROFIBUS Displays will be supplied configured as follows:

Address	126
Keys	Both
Display brightness	100%
Display contrast	50%
Quick access menu	On
Quick access menu code	0000
Configuration menu access code.	0000
Screen	Single variable
Number format	Auto
All alarms	Disabled
Alarm activation	Good data only
Alarm outputs	N/C
Bargraph	
Low	0
High	100
Input scaling	
Zero offset	0
Gain factor	1
Status text	On
Last input	8

6.2 Accessing the display configuration menus

Throughout this manual the four BA484DF-P push buttons are identified **P E ▼ ▲**, and legends displayed by the instrument are shown within inverted commas e.g. 'Enter Access Code'.

Operating the **P** and **E** push buttons simultaneously accesses the display configuration menu. If the BA484DF-P is not protected by an access code the main menu will be displayed. If an access code other than the default code 0000 has already been entered, the BA484DF-P will request that the access code be entered.

Using the ▼ or ▲ button adjust the first digit of the code which will be flashing. Pressing **P** will transfer control to the next digit, which should be adjusted in the same way. When all four digits have been set, pressing the **E** button will enter the access code. If the code is correct the main menu will be displayed, if the code is incorrect 'Invalid Code' will be displayed.

When entering an access code, timeout will occur and the instrument will automatically return to the operating mode ten seconds after a push button was last operated. In all other menus, timeout occurs after sixty seconds.

The structure of the display configuration menu is shown in Fig 7. Navigation is achieved by highlighting the required function using the ▼ and ▲ buttons and then operating the **P** button to display the selected function sub-menu, from which a further selection or adjustment may be made. Operating the **E** button moves the display back up one level.

A flashing highlight indicates that an option or alphanumeric character may be selected using the ▼ and ▲ buttons and entered using the **E** button. If only one entry or adjustment can be made in a sub-menu, the display will automatically move up one menu level when the adjustment is entered. If more than one adjustment can be made in a sub-menu, the highlight may be moved to the second variable using the ▼ or ▲ button after the first setting has been entered. Operating the **P** button allows the second variable to be adjusted.

When multiple numeric or alpha characters are adjusted e.g. an alarm setpoint or a tag legend, the adjustment is made one digit at a time using the ▼ and ▲ buttons. After the first flashing digit has been set as required, the flashing highlight can be moved to the next digit by operating the **P** button. When all digits have been set, operating the **E** button will enter the setting.

Following completion of the instrument configuration, the **E** button should be operated to step the display back to the main menu. One more operation of the **E** button will then return the BA484DF-P to the operating mode.

6.3 Configurable functions

This section provides an explanation of each configurable function and should be read in conjunction with Fig 7. See section 6.3.11 for entering the instrument's PROFIBUS PA address.

6.3.1 Screens (Display format)

The BA484DF-P can display up to eight fieldbus variables that are identified as IN_1 to IN_8. The fieldbus variable that each one represents is determined by the BA484DF-P configuration at the fieldbus system host - see the *PROFIBUS Fieldbus Interface Guide* which may be downloaded from the BEKA website.

This sub-menu allows one of eleven standard display formats to be selected. The standard formats contain one, two, three, four or eight fieldbus variables some with bargraphs as shown below.

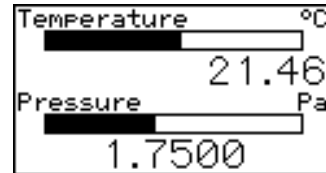

Two variables + horizontal bargraphs

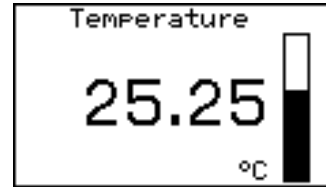

One variable + vertical bargraph

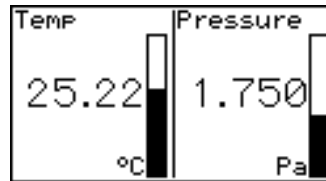

Two variables + vertical bargraphs

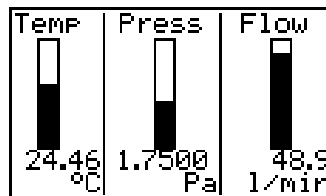

Three variables + vertical bargraphs

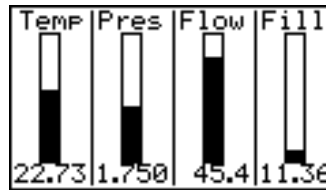

Four variables + vertical bargraphs

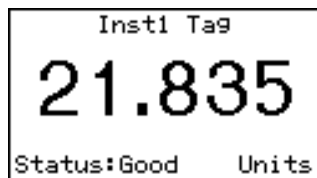

One variable

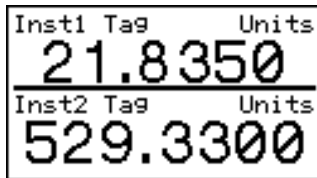

Two variables

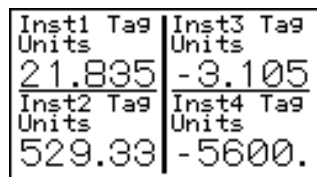

Four variables

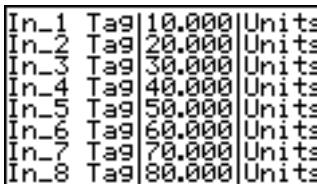

Eight variables

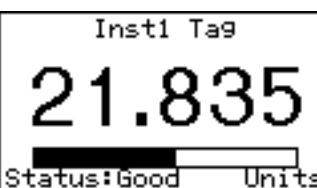

One variable + horizontal bargraph

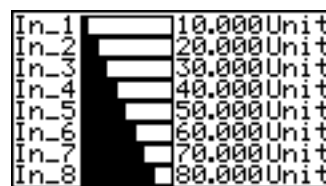

Eight variables + horizontal bargraphs

6.3.2 Input Settings

Each of the eight fieldbus variable inputs may be scaled before being displayed as shown below.

$$\text{Display} = (\text{Gain} \times \text{Fieldbus variable}) + \text{Offset}$$

The sub-functions for each of the eight inputs are:

'Offset' Adds a positive or negative offset to the fieldbus variable before it is displayed.

'Gain' Multiplies the fieldbus variable by a factor before it is displayed.

'Bar Lo' Defines the bargraph lower limit

'Bar Hi' Defines the bargraph higher limit

'Format' Defines the position of the displayed decimal point.

Six options are available:

Auto: Max resolution with selected display format.

4 DP 4 digits on right of decimal point

3 DP 3 digits on right of decimal point

2 DP 2 digits on right of decimal point

1 DP 1 digit on right of decimal point

0 DP No decimal point

The total number of display digits available depends upon the display screen selected – see 6.3.1

Screen	Description	Digits
1	1 variable	5, 7, 11 or 17*
2	2 variables	7
3	4 variables	5
4	8 variables	5
5	1 variable + H bar	5, 7, 11 or 17*
6	2 variables + H bars	7
7	1 variable + V bar	6
8	2 variables + V bars	4
9	3 variables + V bars	6
10	4 variables + V bars	4
11	8 variables + H bars	5

* Font automatically resizes in auto mode

If a negative number is likely to be displayed, a digit must be allocated for the negative sign. If the display overranges all the digits will display '?'.
 For all options leading zeros, apart from the zero in front of a decimal point, are automatically suppressed.

6.3.3 Tags

Each of the eight fieldbus variables may be displayed with an individual tag that can contain up to sixteen alphanumeric characters. This menu allows these tags to be entered. After selecting the required variable, the tag legend is entered character by character using the ▼ and ▲ push buttons. Numbers, upper & lower case letters and symbols are available.

6.3.4 Units

Each of the eight fieldbus variables may be displayed with units of measurement that can contain up to eight alphanumeric characters. This menu allows these units of measurement to be entered. After selecting the required variable, the unit of measurement is entered character by character using the ▼ and ▲ push buttons. Numbers, upper & lower case letters and symbols are available.

6.3.5 Alarms

Alarm menus are only included when the BA484DF-P is fitted with optional alarm outputs. Outputs are locally activated from the fieldbus variables and are configured via the instrument menus and push buttons. They can not be controlled via the fieldbus.

Each of the six alarms may be linked to any one of the eight fieldbus variables displayed by the BA484DF-P. Each alarm output can be conditioned to function as a high or a low alarm, or as a combined high and low alarm. The output can be conditioned as normally open 'N/O' or normally closed 'N/C' in the non-alarm condition. Irrespective of settings all alarm outputs will be open when the instrument is not powered from the fieldbus.

When an alarm is activated, the associated fieldbus variable display flashes, i.e. alternates between dark figures on a light background and light figures on a dark background.

There are eight alarm-conditioning sub-menus.

6.3.5.1 Alarm Summary

Shows to which PROFIBUS variable each alarm is linked and how each alarm has been conditioned. i.e. high, low, or combined high & low alarm with normally open or closed output. No adjustments can be made via this sub-menu.

6.3.5.2 Alarm Activation

PROFIBUS variables that have not been validated are displayed with dark characters on a light background, and some screen formats also contain a status indication. This sub-menu allows the alarm outputs to be conditioned so that they only operate with validated PROFIBUS data, or to operate irrespective of data validity.

6.3.5.3 Alarm Output

There is a separate sub-menu for each of the six alarm outputs; these link the alarm to one of the displayed fieldbus variables and define the alarm function and the setpoints.

To link the alarm to a displayed variable, position the highlight over the 'IN_n' field, press **P** and using the ▼ or ▲ button select the required input source. Enter the selection by pressing the **E** button.

Each alarm output can be N/O or N/C in the non-alarm condition. To change the setting, position the highlight over the 'N/O or N/C' field, press **P** and use the ▼ or ▲ button to toggle the setting. Enter the selection by pressing the **E** button.

Each alarm output has three functions that can be independently enabled to condition the output as a low or high alarm, or as a combined low and high alarm, either with or without hysteresis.

The required functions can be individually enabled by positioning the highlight over the Enb/Dis (Enabled/Disabled) column, pressing **P** and toggling the function to the required state, then entering the selection by pressing the **E** button.

Alarm setpoints are entered digit by digit. Place the highlight over the setpoint to be adjusted and press **P**; the flashing digit to be adjusted may then be selected by again pressing **P**. When all the digits have been adjusted, operating the **E** button enters the value and moves the menu up one level.

The function of all alarms may be reviewed from the alarm summary menu - see 6.3.5.1.

6.3.6 Display

6.3.6.1 Settings

The backlight brilliance and display contrast are adjustable from this sub-menu.

6.3.6.2 Quick Access

This sub-menu enables the Quick Access Menu which is described in sections 2.1 and 6.4. When enabled, an operator can adjust the display contrast and backlight brilliance without having access to any other conditioning menus.

6.3.6.3 Access Code

Defines a four digit alphanumeric code that must be entered to gain access to the Quick Access Menu. Alpha characters are case sensitive. Default code 0000 allows direct access without a code.

6.3.6.4 Status Text

The two single variable screens 1 and 4 will show the status of the PROFIBUS variable as 'Good' or 'Bad' if the Status Text function is activated.

6.3.6.5 Last Input

This function allows the maximum number of PROFIBUS variables to be defined so that unused inputs are skipped when the display is scrolled in the operating mode.

6.3.7 Keys

The function of the front panel push buttons may be transferred to four of the six optional external push buttons, with or without disabling the BA484DF-P front panel push buttons. The table below shows the function of the BA484DF-P front panel and the external push buttons for each of the four options that may be selected in the Keys sub-menu.

Selected option from Keys sub-menu	Push buttons	Function of push buttons			
		Screen scrolling	P+E access to configuration menu	P+Up access to quick access menu	Return Key_Status to host
Internal	BA484DF	Yes	Yes	Yes	Yes*
	External	No	No	No	No
External	BA484DF	No	Yes	No	No
	External	Yes	Yes	Yes	Yes*
Both	BA484DF	Yes	Yes	Yes	Yes*
	External	Yes	Yes	Yes	Yes*
Internal + Port	BA484DF	Yes	Yes	Yes	No
	External	No	No	No	Yes*

* Apart from when 'Internal+Port' is selected, the Key_Status does not function when the instrument is in the configuration menu.

The fourth option 'Internal + Port' allows the front panel push buttons to be used for controlling the BA484DF-P PROFIBUS display and the optional external push buttons to independently enter operator acknowledgements or controls. This option also allows the status of plant mechanical switches to be returned to the host using the DI function blocks.

For applications where the instrument is only displaying 1, 2, 3, 4 or 8 variables on a single screen, it is recommended that external buttons are selected but not fitted. This will disable the instrument front panel buttons, but still provide access to the configuration menu, which may be protected by a security code.

6.3.8 Code

Defines the four digit alphanumeric code that must be entered to gain access to the instrument configuration menus. Alpha characters are case sensitive. Default code 0000 allows direct access without a code.

6.3.9 Unit Info

Displays the instrument model number and the software version.

6.3.10 Defaults

This function enables the display and interface board factory defaults to be restored.

6.3.10.1 Display Defaults

This function restores the display defaults defined in section 6.1.

CAUTION

Existing settings can not be recovered after this function has been used.

6.3.10.2 Interface Board Defaults

This function restores the Fieldbus Interface Board factory defaults.

CAUTION

Do not use this function when the BA484DF-P is connected to an operational PROFIBUS network, as communication to the display will be terminated.

6.3.11 Instrument address

Enables the required three digit PROFIBUS address to be entered digit by digit using the instrument's push buttons.

6.4 Quick Access Menu

The Quick Access Menu allows an operator to adjust the backlight brilliance and the display contrast without having access to the other configuration parameters.

The quick access menu is accessed by operating the **P** and **▲** push buttons simultaneously. If the Quick Access Menu is not protected by an access code the contrast and brilliance controls will be displayed immediately. If an access code other than the default code 0000 has already been entered, the BA484DF-P PROFIBUS display will request that the access code be entered.

The display backlight brilliance is adjusted using the **▼** and **▲** push buttons. Operating the **P** push button will transfer control to the display contrast adjustment. When both are set as required, operating the **E** button will store both settings and return the instrument to the operating mode.

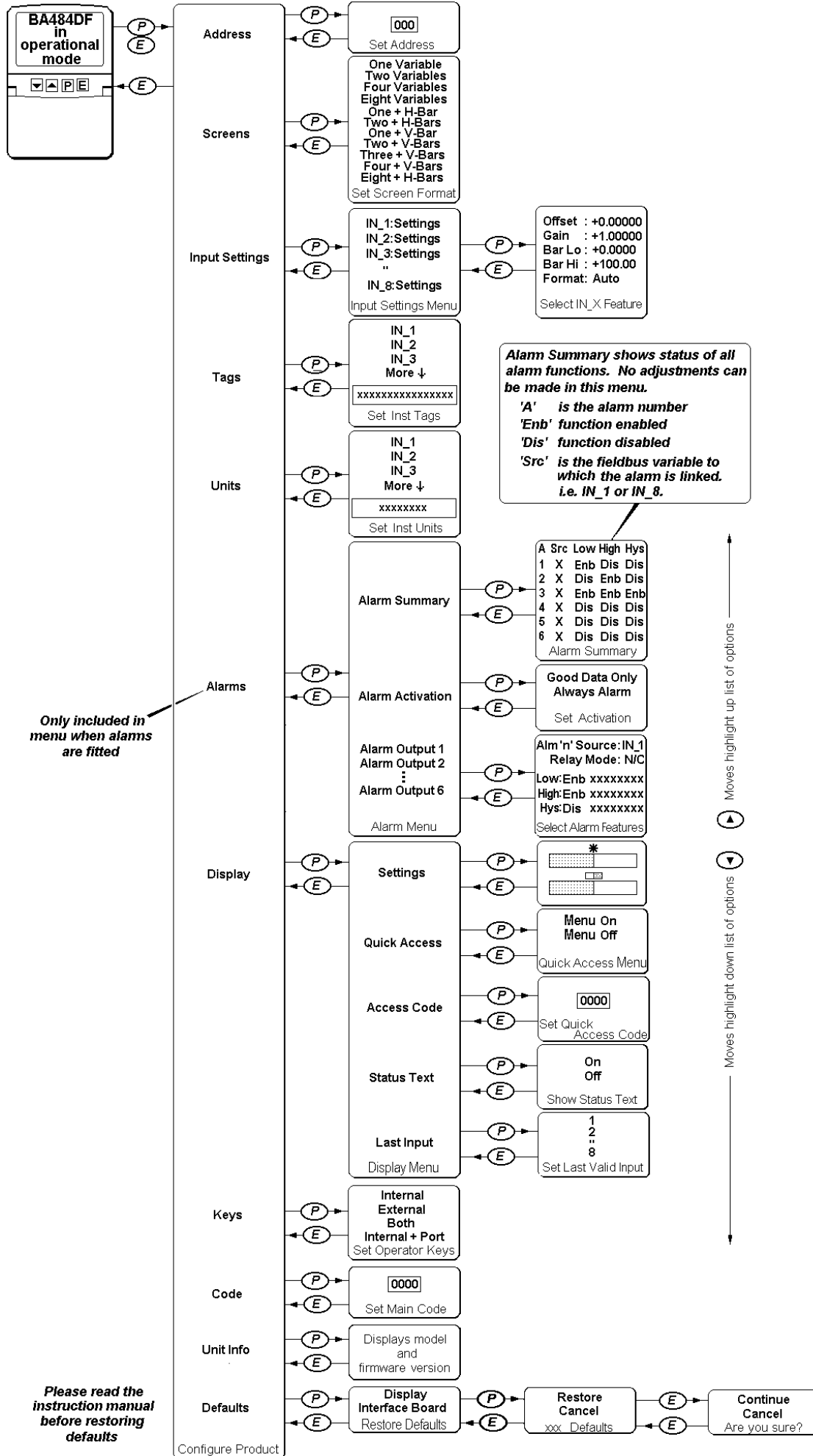

Fig 7 Structure of Configuration Menu

7. MAINTENANCE

7.1 Fault finding during commissioning

If a BA484DF-P PROFIBUS display fails to function during commissioning the following procedure should be followed:

Symptom	Cause	Check:
No Display	Fieldbus not powered	9 to 17.5V between terminals 1 & 2.
No variables	Fieldbus not configured	Instrument configuration at host
Wrong variable displayed	Wrong screen selected	Other screens by operating <i>Up</i> or <i>Down</i> button
Display shows '????'	Display overrange	Number format see section 6.3.2
No backlight	Brilliance turned down	Setting in display menu
Low or excessive contrast	Incorrect contrast setting	Setting in display menu
Displayed variable is inverted i.e. light digits on dark background	Variable has 'bad' status	Configuration and instrument supplying variable
Displayed variable is flashing	Associated alarm has been activated	Setpoints
Bargraph on standard display format is shown dotted	Displayed fieldbus variable is outside bargraph limits or data is 'bad'	Bargraph limits see section 6.3.2

7.2 Fault finding after commissioning

ENSURE PLANT SAFETY BEFORE STARTING MAINTENANCE

Live maintenance is permitted on intrinsically safe equipment installed in a hazardous area, but only certified test equipment should be used unless a gas clearance certificate is available.

If a BA484DF-P PROFIBUS display fails after it has been functioning correctly, the table shown in section 7.1 may help to identify the cause of the failure.

If this procedure does not reveal the cause of the fault, it is recommended that the instrument is replaced.

7.3 Servicing

We recommend that faulty BA484DF-P PROFIBUS displays are returned to BEKA associates or to our local agent for repair.

7.4 Routine maintenance

The mechanical and electrical condition of the instrument should be regularly checked. Initially annual inspections are recommended, although the inspection frequency should be adjusted to suit the environmental conditions.

7.5 Guarantee

Instruments which fail within the guarantee period should be returned to BEKA associates or our local agent. It is helpful if a brief description of the fault symptoms is provided.

7.6 Customer comments

BEKA associates is always pleased to receive comments from customers about our products and services. All communications are acknowledged and whenever possible, suggestions are implemented.

8. ACCESSORIES

8.1 Tag plate

The BA484DF-P PROFIBUS display can be supplied with a blank or custom engraved stainless steel plate secured by two screws to the side of the instrument enclosure. This plate can accommodate:

1 row of 9 alphanumeric characters 10mm high

or 1 row of 11 alphanumeric characters 7mm high

or 2 rows of 18 alphanumeric characters 5mm high

8.2 Pipe mounting kits

Two pipe mounting kits are available for securing the BA484DF-P PROFIBUS display to a horizontal or vertical pipe.

BA392D Stainless steel bracket secured by two worm drive hose clips for 60 to 80mm outside diameter pipes.

BA393 Heavy duty stainless steel bracket secured by a single 'V' bolt. Will clamp to any pipe with an outside diameter between 40 and 80mm.

8.3 PROFIBUS Interface Guides

The BEKA PROFIBUS Interface Guide, which may be downloaded from the BEKA web site at www.beka.co.uk contains conditioning information for all BEKA PROFIBUS products.

10. INDEX

Subject	Section	Subject	Section
Address	6.3.11	Notified Body	1; 3.1
Alarms	6.3.5	Number Format	6.3.2
Activation	6.3.5.2	Pipe mounting kits	9.2
Output	3.5; 6.3.5.3; 4.4	Programming	7.
Summary	6.3.5.1	Guide	7; 9.3
ATEX Directive	3.1	PROFIBUS PA	1; 2
Dust certification	Appendix 1	Quick access menu	6.3.6.2; 6.4
Backlight	6.3.6.1	Revisions 1 & 2	1; 6.3.10.3
Bargraph limits	6.3.2	Servicing	8.3
Certificates		Screens (display format)	6.3.1
EC-Type Examination	3.1	Tags	6.3.3
Label	3.6	Tag plate	9.1
Configuration menu	Fig 7	T rating	3.2
Controls	2.1	Terminal numbers	Fig 6
Code	6.3.8	Units (of measurement)	6.3.4
Decimal Points	6.3.2	Unit Info (firmware version)	6.3.9
Default settings	6.1; 6.3.10	Zones	3.2;
Display	6.3.6		Appendix 1; 2; 3
Access code	6.3.6.3		
Settings	6.3.6.1		
Quick access	6.3.6.2; 6.4		
Dust certification	Appendix 1; 2; 3		
EMC	5.3		
External switches	3.4; 4.3; 6.3.7		
Fault finding			
During commissioning	8.1		
After commissioning	8.2		
Fieldbus			
Connection	3.3		
Foundation	1; 2		
Guide	9.4		
Revisions 1 & 2	6.3.10.3		
FISCO	3.3; 4.1		
FM Approval	Appendix 2		
Function Blocks	1; 6.3.10.3		
Gas groups	3.2		
Guarantee	8.5		
IECEX Certification	Appendix 3		
Input scaling	6.3.12		
Installation	5		
Intrinsic safety	3; Appendix 1; 2; 3		
Keys	6.3.7		
Location	5.1;		
	Appendix 1; 2; 3		
Maintenance	8.		
Routine	8.4		

APPENDIX 1 ATEX dust certification

A1.0 ATEX dust certification

In addition to ATEX certification permitting installation in explosive gas atmospheres which is described in the main section of this instruction manual, the BA484DF-P is available ATEX certified for use in the presence of combustible dusts. If ATEX dust certification is required it must be reequested when the BA484DF-P Fieldbus Display is purchased.

WARNING

Before installing a BA484DF-P Fieldbus Display in the presence of a combustible dust, ensure that the certification information label which is located on the top of the instrument specifies dust certification - see section A1.2

A1.1 Zones and Maximum Surface Temperature

The BA484DF-P has been ATEX certified as Group II, Category 1 D apparatus $T_{amb} = -40$ to 60°C , with a Maximum Surface Temperature of 125°C . When installed as specified by IEC 60079-14, the Fieldbus Display may be installed in:

- Zone 20 explosive atmosphere in the form of a cloud of combustible dust in air is continuously present, or for long periods or frequently.
- Zone 21 explosive atmosphere in the form of a cloud of combustible dust in air is likely to occur occasionally in normal operation.
- Zone 22 explosive atmosphere in the form of a cloud of combustible dust in air is not likely to occur in normal operation, but if it does occur, will only persist for a short period.

Be used with dusts having a Minimum Ignition Temperature of:

Dust cloud	188°C
Dust layer on BA484DF-P up to 5mm thick	200°C
Dust layer on BA484DF-P over 5mm thick.	Refer to EN 60079:14

At an ambient temperature between -40 and $+60^{\circ}\text{C}$

Note: the guaranteed operating temperature range of the Fieldbus Display is -20 to $+60^{\circ}\text{C}$

A1.2 Certification Label Information

The certification label is fitted in a recess on the top outer surface of the enclosure. It shows the ATEX dust certification information including the maximum surface temperature and ingress protection, plus the ATEX gas certification information. Non European information may also be shown.

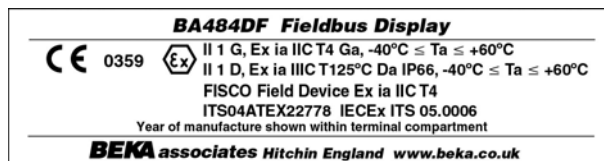

The instrument serial number and date of manufacture are recorded on a separate label inside the terminal compartment.

A1.3 Calibration & maintenance

The ATEX dust certification relies on the Fieldbus Display enclosure being dust-tight. Therefore the control and terminal covers should only be removed when dust can not enter the instrument enclosure. Before replacing the control and terminal covers ensure that the sealing gaskets are undamaged and are free from foreign bodies.

APPENDIX 2
FM approval for use in the USA

A2.0 Factory Mutual Approval

For installations in the USA, the BA484DF-P and optional alarms have been approved intrinsically safe and nonincendive by FM Approvals, project identification 3022546. Copies of the Certificate of Compliance are available from BEKA associates.

The FM Approved version of the BA484DF-P Fieldbus Display is identical to the ATEX version except the three M20 x 1,5 tapped cable entries are replaced by three plain unthreaded 22.25mm diameter entries. Approved hubs and glands are listed in note 8 of Control Drawing CI480-17 and note 7 of Control Drawing CI480-18. The certification label on the FM Approved version includes ATEX gas certification information so that the Fieldbus Display may be used in systems covered by either authority.

A2.1 Intrinsic safety approval

The BA484DF-P is approved to the FM Class 3610 intrinsic safety standard for use in indoor and outdoor hazardous (classified) locations. Installations must comply with BEKA associates Control Drawing CI480-17, which is attached to this Appendix, ANSI/ISA RP12.06.01 'Installation of Intrinsically Safe Systems for Hazardous (Classified) Locations' and with the National Electrical Code ANSI/NFPA70.

The BA484DF-P has a T4 rating at ambient temperatures up to +60°C and may be used with the following gases and dusts:

Intrinsic Safety	
Division 1 or 2	
Class I	Group A & B Group C Group D
Class II	Group E, F & G
Class III	
Zone 0, 1 or 2	
Class 1	Group IIC Group IIB Group IIA

The FM entity parameters are identical to the ATEX parameters and, like the ATEX certification, confirm that terminals 1 & 2 of the BA484DF-P comply with the requirements for a FISCO Field Device specified in IEC60079-27. The intrinsically safe circuits shown in Figs 2 and 3 of this manual may therefore be used for installations in the USA, providing the fieldbus power supply, terminators, Zener barriers and galvanic isolators are FM Approved and comply with BEKA associates Control Drawing CI480-17. The FM Approval also allows the BA484DF-P to be connected to non-FISCO systems using the entity concept – see section 4.2 of this manual.

A2.2 Nonincendive approval

The BA484DF-P is Class 3611 nonincendive approved by Factory Mutual allowing it to be installed in Division 2 indoor and outdoor hazardous (classified) locations without the need for Zener barriers or galvanic isolators. Installations must comply with the BEKA associates Control Drawing CI480-18, which is attached to this Appendix, and with the National Electrical Code ANSI/NFPA70.

The FM Nonincendive Approval also allows the instrument to be connected to any FNICO compliant fieldbus segment powered by FM Approved Associated Nonincendive Field Wiring Apparatus.

The BA484DF-P has a T4 rating at ambient temperatures up to +60°C and may be used with the following gases and dusts:

Nonincendive	
Division 2	
Class I	Group A & B Group C Group D
Class II	Groups E, F & G
Class III	
Zone 2	
Class I	Group IIC Group IIB Group IIA

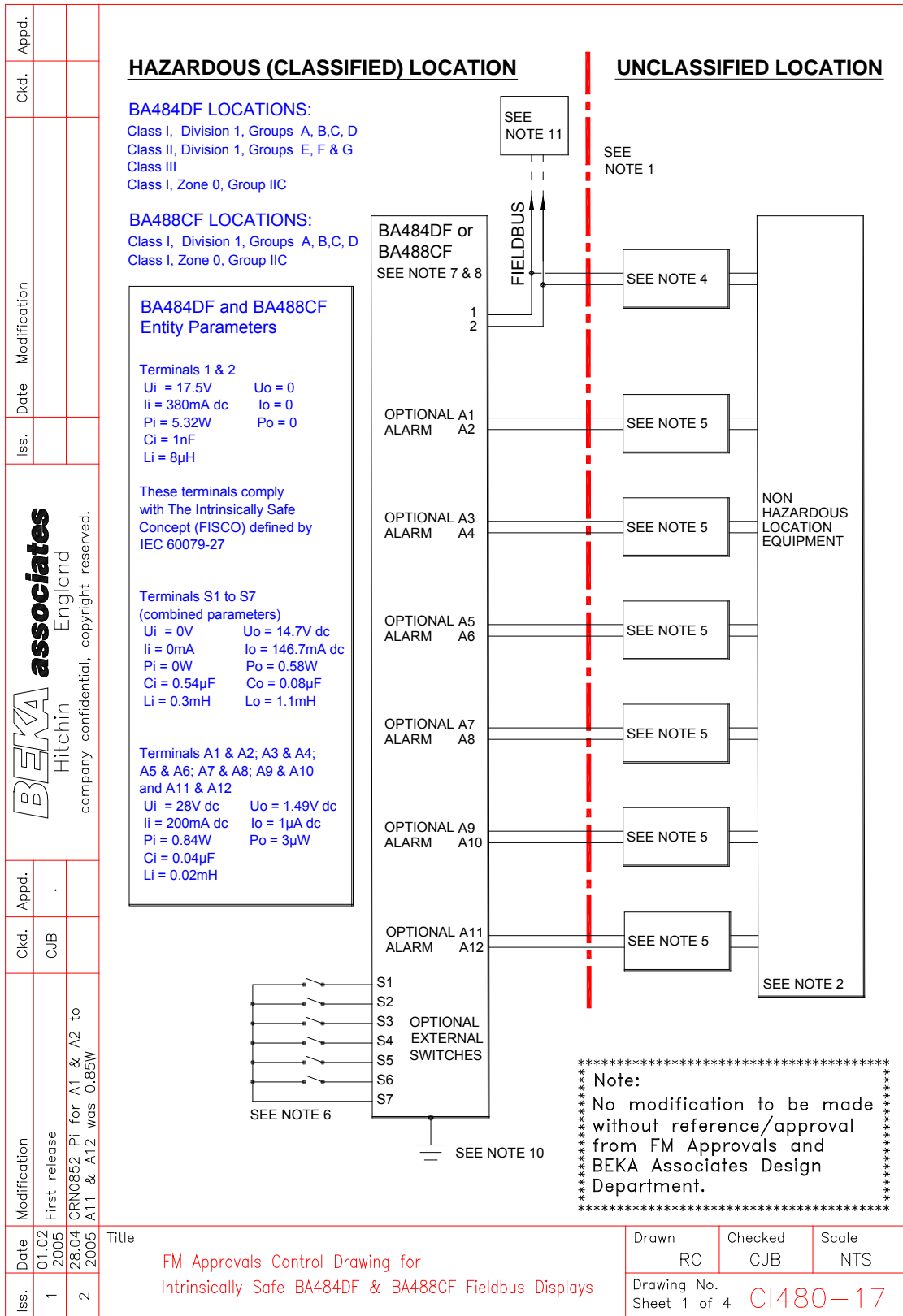

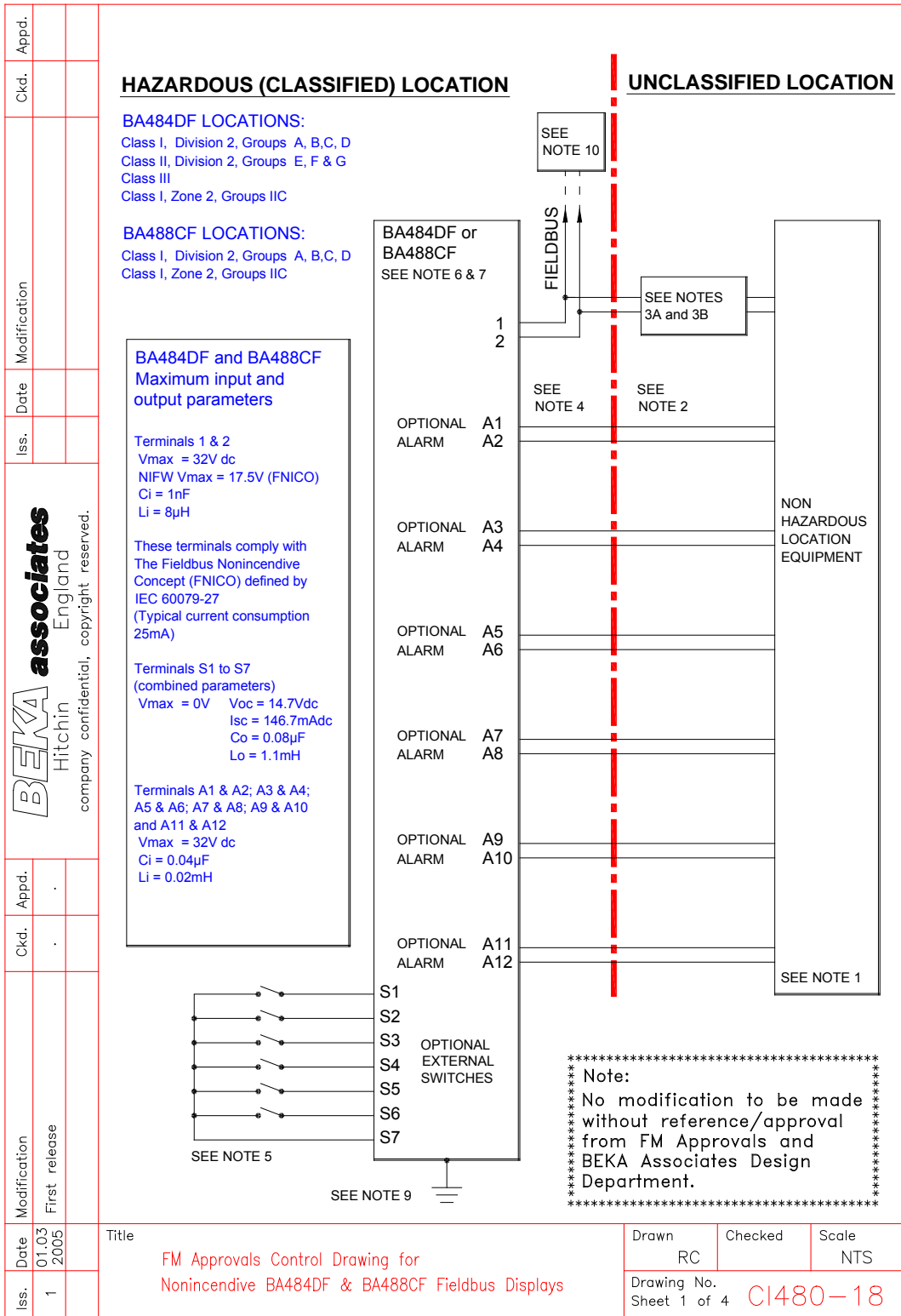

Iss.	Date	Modification	Ckd.	Appd.		Iss.	Date	Modification	Ckd.	Appd.	<p>8. When installed in a hazardous (classified) location the BA484DF Fieldbus Display shall be fitted with cable glands / conduit hubs selected from the following table Metallic glands and hubs must be grounded – see note 9.</p> <table border="1" data-bbox="539 488 1295 878"> <thead> <tr> <th>Class</th> <th>Permitted gland or conduit hub</th> </tr> </thead> <tbody> <tr> <td>Class I</td> <td>Any metallic or plastic cable gland or conduit hub that provides the required environmental protection.</td> </tr> <tr> <td>Class II and III</td> <td> Crouse – Hinds Myler hubs SSTG-1 STG-1 STAG-1 MHUB-1 O-Z / Gedrey Hubs CHMG-50DT REMKE hub WH-1-G Killark Glands CMCXAA050 MCR050 MCX050 </td> </tr> </tbody> </table>	Class	Permitted gland or conduit hub	Class I	Any metallic or plastic cable gland or conduit hub that provides the required environmental protection.	Class II and III	Crouse – Hinds Myler hubs SSTG-1 STG-1 STAG-1 MHUB-1 O-Z / Gedrey Hubs CHMG-50DT REMKE hub WH-1-G Killark Glands CMCXAA050 MCR050 MCX050
												Class	Permitted gland or conduit hub				
Class I	Any metallic or plastic cable gland or conduit hub that provides the required environmental protection.																
Class II and III	Crouse – Hinds Myler hubs SSTG-1 STG-1 STAG-1 MHUB-1 O-Z / Gedrey Hubs CHMG-50DT REMKE hub WH-1-G Killark Glands CMCXAA050 MCR050 MCX050																
1	01.02 2005	First release	CJB	.	company confidential, copyright reserved.	2	28.04 2005	CRN0852 See sheet 1			<p>9. In addition to the supplied bonding plate, when 2 or 3 metallic glands or conduit hubs are fitted to a BA484DF Fieldbus Display, all metallic glands or conduit hubs must be connected together and grounded.</p> <p>10. CAUTION: The BA484DF and BA488CF Fieldbus Display enclosures are manufactured from conductive plastic per Article 250 of the National Electrical Code the enclosures shall be grounded using the 'E' terminal on the terminal block.</p> <p>11. The terminator on the Fieldbus must be FM Approved.</p> <p>12. The BA484DF should be mounted where it is shielded from direct sunlight.</p> <p style="text-align: right;">Cont.</p>						
Title						Drawn RC Checked CJB Scale NTS			Drawing No. Sheet 3 of 4 CI480-17								
FM Approvals Control Drawing for Intrinsically Safe BA484DF & BA488CF Fieldbus Displays																	

Iss.	Date	Modification	Ckd.	Appd.	 <p>Hitchin England company confidential, copyright reserved.</p>	Iss.	Date	Modification	Ckd.	Appd.	<p>FISCO Rules</p> <p>The FISCO Concept allows the interconnection of intrinsically safe apparatus to associated apparatus not specifically examined in such combination. The criterion for such interconnection is that the voltage (Vmax), the current (Imax) and the power (Pmax) which intrinsically safe apparatus can receive and remain intrinsically safe, considering faults, must be equal or greater than the voltage (Uo, Voc or Vt), the current (Io, Isc or It) and the power (Po) which can be provided by the associated apparatus (supply unit). In addition the maximum unprotected residual capacitance (Ci) and inductance (Li) of each apparatus (other than terminators) connected to the Fieldbus must be less than or equal to 5nF and 10uH respectively.</p> <p>In each I.S. Fieldbus segment only one active source, normally the associated apparatus, is allowed to provide the necessary power for the Fieldbus system. The allowed voltage (Uo, Voc or Vt) of the associated apparatus used to supply the bus cable must be limited to the range 14Vdc to 24Vdc. All other equipment connected to the bus cable has to be passive, meaning that the apparatus is not allowed to provide energy to the system, except a leakage current of 50µA for each connected device. Separately powered equipment needs galvanic isolation to ensure the intrinsically safety Fieldbus circuit remains passive.</p> <p>The cable used to interconnect the devices needs to comply with the following parameters: Loop resistance R': 15....150Ω/km Inductance per unit length L':0.4....1mH/km</p> <p>Capacitance per unit length C': 80....200nF/km C' = C' line/line+0.5 C' line/screen, if both lines are floating or C' = C' line/line + C'line/screen, if the screen is connected to one line. Length of spur cable: max. 30m Length of trunk cable: max. 1km Length of splice: max = 1m Terminators At the end of each trunk cable an FM Approved line terminator with the following parameters is suitable: R= 90....100Ω C = 02.2µF</p> <p>System evaluation The number of passive devices like transmitters, actuators, connected to a single bus segment is not limited due to I.S. reasons. Furthermore, if the above rules are respected, the inductance and the capacitance of the cable need not be considered and will not impair the intrinsic safety of the installation.</p> <p>Notes. 1. The intrinsic safety FISCO concept allows the interconnection of FM Approved Intrinsically Safe devices with FISCO parameters not specifically examined in combination as a system when: Uo or Voc or Vt ≤ Vmax, Io, Isc or It ≤ Imax, Po ≤ Pi."</p>
2	28.04 2005	CRN0852 See sheet 1									
Title					Drawn	Checked	Scale				
FM Approvals Control Drawing for Intrinsically Safe BA484DF & BA488CF Fieldbus Displays					RC	CJB	NTS				
					Drawing No. Sheet 4 of 4		CI480-17				

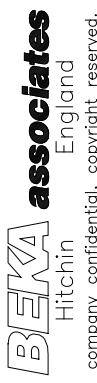

Iss.	Date	Modification	Ckd.	Appd.	<p>Notes:</p> <ol style="list-style-type: none"> The unclassified location equipment connected to the associated nonincendive field wiring apparatus must not use or generate more than 250V rms or 250V dc. Nonincendive field wiring installations shall be in accordance with the National Electrical Code ANSI/NFPA 70. The Nonincendive Field Wiring concept allows interconnection of Nonincendive Field Wiring Apparatus with Associated Nonincendive Field Wiring Apparatus using any of the wiring methods permitted for unclassified locations. Linear power supply A linear fieldbus power supply shall be: FM Approved Associated Nonincendive Field Wiring Apparatus installed in the unclassified location with parameters complying with the following requirements: OR FM Approved Nonincendive Field Wiring Apparatus installed in the classified location with parameters complying with the following requirements: <table border="0"> <tr> <td>Voc</td> <td>equal to or less than</td> <td>Vmax</td> </tr> <tr> <td>La</td> <td>equal to or greater than</td> <td>Lcable + Li</td> </tr> <tr> <td>Ca</td> <td>equal to or greater than</td> <td>Ccable + Ci</td> </tr> </table> FNICO non-linear power supply A FNICO non-linear fieldbus power supply shall be: FM Approved Associated Nonincendive Field Wiring Apparatus installed in the unclassified location complying with the following table: OR FM Approved Nonincendive Field Wiring Apparatus installed in the classified location complying with the following table: <table border="0"> <tr> <td>Voc</td> <td>Maximum current for Groups AB [IIC]</td> <td>Maximum current for Groups CD [IIB, IIA]</td> </tr> <tr> <td>V</td> <td>mA</td> <td>mA</td> </tr> <tr> <td>14</td> <td>274</td> <td>570</td> </tr> <tr> <td>15</td> <td>199</td> <td>531</td> </tr> <tr> <td>16</td> <td>154</td> <td>432</td> </tr> <tr> <td>17</td> <td>121</td> <td>360</td> </tr> <tr> <td>17.5</td> <td>112</td> <td>319</td> </tr> </table> Apparatus connected to the optional alarm contacts shall be FM Approved as Associated Nonincendive Field Wiring Apparatus and shall comply with the following requirements: <table border="0"> <tr> <td>Voc</td> <td>equal to or less than</td> <td>Vmax</td> </tr> <tr> <td>La</td> <td>equal to or greater than</td> <td>Lcable + Li</td> </tr> <tr> <td>Ca</td> <td>equal to or greater than</td> <td>Ccable + Ci</td> </tr> </table> Terminals S1 to S7 shall be connected to simple apparatus or volt free contacts of FM Approved Nonincendive Field Wiring Apparatus or FM Approved Associated Nonincendive Field Wiring Apparatus installed using Division 2 wiring methods. To maintain IP65 protection between the BA488CF and the mounting panel: Four panel mounting clips should be used Minimum panel thickness should be 2mm (0.08inches) Steel 3mm (0.12inches) Aluminium Outside panel finish should be smooth, free from particle inclusions, runs or build-up around cut-out. Panel cut-out should be 66.2 x 136.0mm -0.0 +0.5 (2.60 x 5.35 inches -0.00 +0.02) Edges of panel cut-out should be deburred and clean Each panel mounting clip should be tightened to between: 20 and 22cNm (1.77 to 1.95 inLb) <p style="text-align: center;">Cont.</p> 	Voc	equal to or less than	Vmax	La	equal to or greater than	Lcable + Li	Ca	equal to or greater than	Ccable + Ci	Voc	Maximum current for Groups AB [IIC]	Maximum current for Groups CD [IIB, IIA]	V	mA	mA	14	274	570	15	199	531	16	154	432	17	121	360	17.5	112	319	Voc	equal to or less than	Vmax	La	equal to or greater than	Lcable + Li	Ca	equal to or greater than	Ccable + Ci
Voc	equal to or less than	Vmax																																										
La	equal to or greater than	Lcable + Li																																										
Ca	equal to or greater than	Ccable + Ci																																										
Voc	Maximum current for Groups AB [IIC]	Maximum current for Groups CD [IIB, IIA]																																										
V	mA	mA																																										
14	274	570																																										
15	199	531																																										
16	154	432																																										
17	121	360																																										
17.5	112	319																																										
Voc	equal to or less than	Vmax																																										
La	equal to or greater than	Lcable + Li																																										
Ca	equal to or greater than	Ccable + Ci																																										
Iss.	Date	Modification	Ckd.	Appd.																																								
1	01.03 2005	First release	.	.																																								
<p>BEMA associates Hitchin England company confidential, copyright reserved.</p>																																												
<p>Title</p> <p>FM Approvals Control Drawing for Nonincendive BA484DF & BA488CF Fieldbus Displays</p>			<p>Drawn</p> <p>RC</p>	<p>Checked</p>	<p>Scale</p> <p>NTS</p>																																							
			<p>Drawing No.</p> <p>Sheet 2 of 4</p> <p style="color: red; font-size: 1.2em;">CI480-18</p>																																									

Iss.	Date	Modification	Ckd.	Appd.						
1	01.03 2005	First release	.	.						
 BEVA associates Hitchin England company confidential, copyright reserved.										
<p>7. When installed in a hazardous (classified) location the BA484DF Fieldbus Display shall be fitted with cable glands / conduit hubs selected from the following table.</p> <p style="padding-left: 40px;">Metallic glands and hubs must be grounded – see note 8.</p> <table border="1" style="margin-left: auto; margin-right: auto;"> <thead> <tr> <th>Class</th> <th>Permitted gland or conduit hub</th> </tr> </thead> <tbody> <tr> <td>Class I</td> <td>Any metallic or plastic cable gland or conduit hub that provides the required environmental protection.</td> </tr> <tr> <td>Class II and III</td> <td> Crouse – Hinds Myler hubs SSTG-1 STG-1 STAG-1 MHUB-1 O-Z / Gedrey hub CHMG-50DT REMKE hub WH-1-G Killark Glands CMCXAA050 MCR050 MCX050 </td> </tr> </tbody> </table> <p>8. In addition to the supplied bonding plate, when 2 or 3 metallic glands or conduit hubs are fitted to a BA484DF Fieldbus Display, all metallic glands or conduit hubs must be connected together and grounded.</p> <p>9. CAUTION: The BA484DF and BA488CF Fieldbus Display enclosures are manufactured from conductive plastic per Article 250 of the National Electrical Code the enclosures shall be grounded using the 'E' terminal on the terminal block.</p> <p>10. The terminator on the Fieldbus must be FM Approved.</p> <p>11. The BA484DF should be mounted where it is shielded from direct sunlight.</p> <p style="text-align: right;">Cont.</p>					Class	Permitted gland or conduit hub	Class I	Any metallic or plastic cable gland or conduit hub that provides the required environmental protection.	Class II and III	Crouse – Hinds Myler hubs SSTG-1 STG-1 STAG-1 MHUB-1 O-Z / Gedrey hub CHMG-50DT REMKE hub WH-1-G Killark Glands CMCXAA050 MCR050 MCX050
Class	Permitted gland or conduit hub									
Class I	Any metallic or plastic cable gland or conduit hub that provides the required environmental protection.									
Class II and III	Crouse – Hinds Myler hubs SSTG-1 STG-1 STAG-1 MHUB-1 O-Z / Gedrey hub CHMG-50DT REMKE hub WH-1-G Killark Glands CMCXAA050 MCR050 MCX050									
Date		Title		Drawn						
01.03 2005	FM Approvals Control Drawing for Nonincendive BA484DF & BA488CF Fieldbus Displays		RC	Checked						
1				Scale						
				NTS						
			Drawing No. Sheet 3 of 4 CI480-18							

Iss.	1	Date	01.03 2005	Modification	First release	Appd.	.	Ckd.	.		
Iss.		Date		Modification		Appd.		Ckd.			
											
<p>FNICO Rules</p> <p>The FNICO Concept allows the interconnection of intrinsically safe apparatus to associated apparatus not specifically examined in such combination. The criterion for such interconnection is that the voltage (Vmax), the current (Imax) and the power (Pmax) which intrinsically safe apparatus can receive and remain intrinsically safe, considering faults, must be equal or greater than the voltage (Uo, Voc or Vt), the current (Io, Isc or It) and the power (Po) which can be provided by the associated apparatus (supply unit). In addition the maximum unprotected residual capacitance (Ci) and inductance (Li) of each apparatus (other than terminators) connected to the Fieldbus must be less than or equal to 5nF and 20uH respectively.</p> <p>In each I.S. Fieldbus segment only one active source, normally the associated apparatus, is allowed to provide the necessary power for the Fieldbus system. The allowed voltage (Uo, Voc or Vt) of the associated apparatus used to supply the bus cable must be limited to the range 14Vdc to 17.5Vdc. All other equipment connected to the bus cable has to be passive, meaning that the apparatus is not allowed to provide energy to the system, except a leakage current of 50µA for each connected device. Separately powered equipment needs galvanic isolation to ensure the intrinsically safety Fieldbus circuit remains passive.</p> <p>The cable used to interconnect the devices needs to comply with the following parameters: Loop resistance R': 15....150Ω/km Inductance per unit length L':0.4....1mH/km Capacitance per unit length C': 80....200nF/km $C' = C' \text{ line/line} + 0.5 C' \text{ line/screen}$, if both lines are floating or $C' = C' \text{ line/line} + C' \text{ line/screen}$, if the screen is connected to one line. Length of spur cable: max. 30m Length of trunk cable: max. 1km Length of splice: max = 1m Terminators At the end of each trunk cable an FM Approved line terminator with the following parameters is suitable: $R = 90...100\Omega$ $C = 0...2.2\mu F$</p> <p>System evaluation The number of passive devices like transmitters, actuators, connected to a single bus segment is not limited due to nonincendive reasons. Furthermore, if the above rules are respected, the inductance and the capacitance of the cable need not be considered and will not impair the intrinsic safety of the installation.</p> <p>Notes. 1. The intrinsic safety FNICO concept allows the interconnection of FM Approved nonincendive devices with FNICO parameters not specifically examined in combination as a system when: $U_o \text{ or } V_{oc} \text{ or } V_t \leq V_{max}$"</p>											
Title						Drawn		Checked		Scale	
FM Approvals Control Drawing for Nonincendive BA484DF & BA488CF Fieldbus Displays						RC				NTS	
						Drawing No.		Sheet 4 of 4			
								CI480-18			

APPENDIX 3 IECEX Certification

A3.0 The IECEX Certification Scheme

IECEX is a global certification scheme for explosion protected products which aims to harmonise international certification standards.

For additional information about the IECEX certification scheme and to view the BEKA associate certificates, please visit www.iecex.com

A3.1 IECEX Certificate of Conformity

The BA484DF-P Fieldbus Display has been issued with an IECEX Certificate of Conformity number IECEX ITS 05.0006 which specifies the following certification codes and marking:

For gas Ex ia IIC T4 Ga
 Ta = -40°C to 60 °C

For dust Ex ia IIIC T125°C Da IP66
 Ta = -40°C to 60°C

The specified intrinsic safety parameters are identical to the ATEX parameters and confirm that terminals 1 & 2 comply with the requirements for a FISCO Field Device specified in IEC60079-11.

The IECEX certificate may be downloaded from www.beka.co.uk, www.iecex.com or requested from the BEKA sales office.

A3.2 Versions of the BA484DF-P

All versions of the BA484DF-P Fieldbus Display have IECEX certification. This includes:

ATEX version for use in gas atmospheres.

IECEX code Ex ia IIC T4 Ga
 Ta = -40°C to 60°C

ATEX version for use in gas and dust atmospheres.

IECEX code Ex ia IIC T4 Ga
 Ex ia IIIC T125°C Da IP66
 Ta = -40°C to 60°C

Factory Mutual Approved version

IECEX code Ex ia IIC T4 Ga
 Ta = -40°C to 60°C

A3.3 Installation

As the IECEX and ATEX certifications specify identical safety parameters and installation requirements for both are defined by IEC 60079-14, the ATEX installation requirements specified in sections 3.2 to 5.3 may therefore also be used for IECEX installations in gas or dust atmospheres. The local code of practice should also be consulted.