

CERTIFICATE OF COMPLIANCE

HAZARDOUS LOCATION ELECTRICAL EQUIPMENT PER CANADIAN REQUIREMENTS

This certificate is issued for the following equipment:

BA414DF a Fieldbus Indicator

BA444DF a Fieldbus Indicator

BA444DL a Fieldbus listener

BA424DF a Fieldbus set point station

IS / I, II, III / 1 / ABCDEFG / T4 Ta = 70°C – CI410-12; Entity, FISCO IP66;

I / 0 / Ex ia IIC T4 Ta = 70°C – CI410-12; Entity, FISCO IP66;

IPA / I, II, III / 2 / ABCDEFG / T4 Ta = 70°C – CI410-13; NIFW, FNICO IP66;

I / 2 / IIC / T4 Ta = 70°C – CI410-13; NIFW, FNICO IP66;

a = certification or options not affecting safety

Intrinsic Safety Parameters –

	Terminals	Ui (V)	Ii (mA)	Pi (W)	Ci (nF)	Li (µH)
Entity	1 & 2	22	250	1.2	0	8
FISCO	1 & 2	17.5	380	5.32	0	8

Nonincendive Parameters –

	Terminals	Ui (V)	Ci (nF)	Li (µH)
NIFW	1 & 2	32	0	8
FNICO	1 & 2	17.5	0	8

Special conditions of use

- The BA414DF, BA444DF, BA444DL, and BA424DF shall be protected from direct exposure to sunlight.

BA418CF a Fieldbus Indicator

BA448CF a Fieldbus Indicator

BA448CL a Fieldbus listener

BA428CF a Fieldbus set point station

IS / I / 1 / ABCD / T4 Ta = 70°C – CI410-12; Entity, FISCO IP66

I / 0 / AEx ia IIC T4 Ta = 70°C – CI410-12; Entity, FISCO IP66

NI / I / 2 / ABCD / T4 Ta = 70°C – CI410-13; NIFW, FNICO IP66

I / 2 / IIC / T4 Ta = 70°C – CI410-13; NIFW, FNICO IP66

a = certification or options not affecting safety

Intrinsic Safety Parameters –

	Terminals	Ui (V)	Ii (mA)	Pi (W)	Ci (nF)	Li (µH)	Member of FM Global Group
Entity	1 & 2	22	250	1.2	0	8	
FISCO	1 & 2	17.5	380	5.32	0	8	

Nonincendive Parameters –

	Terminals	Ui (V)	Ci (nF)	Li (µH)
NIFW	1 & 2	32	0	8
FNICO	1 & 2	17.5	0	8

Special conditions of use

1. To maintain the IP66 enclosure rating the BA418CF, BA448CF, BA448CL and BA428CF shall be installed in accordance with the mounting conditions provided on drawing numbers CI410-12 and CI410-13.
2. The BA418CF, BA448CF, BA448CL and BA428CF shall be installed in compliance with the enclosure, mounting, spacing and segregation requirements of the ultimate application.
3. The BA418CF, BA448CF, BA448CL and BA428CF shall be protected from direct exposure to sunlight.

Equipment Ratings:

BA414DF, BA444DF, BA444DL, and BA424DF – Intrinsically Safe for Class I, II and III, Division 1, Groups A, B, C, D, E, F and G; Class I, Zone 0, Group IIC in accordance with the Entity and FISCO concepts and when installed in accordance with Control Drawing CI410-12; Ignition Protected Apparatus for Class I, Division 2, Groups A, B, C and D; Class I, Zone 2, Group IIC; in accordance with the Nonincendive Field Wiring Concept and FNICO and when installed in accordance with Control Drawing CI410-13; hazardous (classified) locations.

BA418CF, BA448CF, BA448CL and BA428CF – Intrinsically Safe for Class I, Division 1, Groups A, B, C, and D; Class I, Zone 0, Group IIC in accordance with the Entity and FISCO concepts and when installed in accordance with Control Drawing CI410-12; nonincendive for Class I, Division 2, Groups A, B, C and D; Class I, Zone 2, Group IIC; in accordance with the Nonincendive Field Wiring Concept and FNICO and when installed in accordance with Control Drawing CI410-13; hazardous (classified) locations.

FM Approved for:

BEKA associates Ltd
Hitchin, Hertfordshire, UNITED KINGDOM SG5 2DA



Member of the FM Global Group

This certifies that the equipment described has been found to comply with the following Approval Standards and other documents:

C22.2 No. 142	1993
C22.2 No. 157	2002
C22.2 No. 213	1987
E60079-0	2002
E60079-11	2002

Original Project ID: 3027031C

Approval Granted: November 22, 2006

Subsequent Revision Reports / Date Approval Amended

Report Number	Date	Report Number	Date
070103	January 15, 2007		
090209	October 1, 2009		

FM Approvals LLC

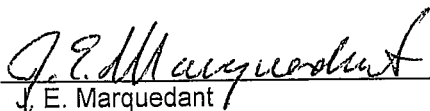

J. E. Marquedant
Group Manager, Electrical

1 October 2009
Date

Iss.	Date	Modification	Ckd.	Appd.
1	28.03.2006	First release		
2	15.09.2009	Provision for alternative instrument titles added.		

BEKA associates
 Hitchin England
 company confidential, copyright reserved.

HAZARDOUS (CLASSIFIED) LOCATION

UNCLASSIFIED LOCATION

BA414DF LOCATIONS:
 Class I, Division 1, Groups A, B,C, D
 Class II, Division 1, Groups E, F & G
 Class III
 Class I, Zone 0, Group IIC

BA418CF LOCATIONS:
 Class I, Division 1, Groups A, B,C, D
 Class I, Zone 0, Group IIC

BA414DF and BA418CF

Terminals 1 & 2
 These terminals comply with the Intrinsically Safe Concept (FISCO) defined by IEC 60079-27

$U_i = 17.5V$ $U_o = 0$
 $I_i = 380mA$ dc $I_o = 0$
 $P_i = 5.32W$ $P_o = 0$
 $C_i = 0$
 $L_i = 8\mu H$

and have the following Entity Parameters

$U_i = 22Vdc$ $U_o = 0$
 $I_i = 250mA$ $I_o = 0$
 $P_i = 1.2W$ $P_o = 0$

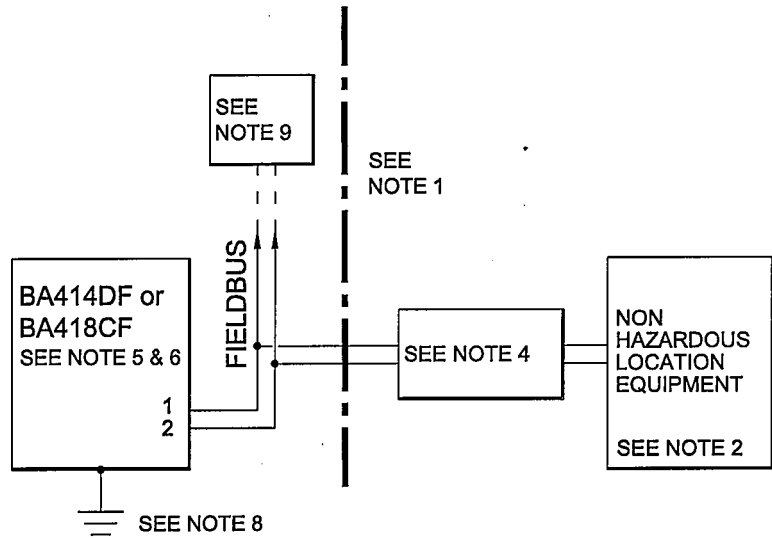

 Note:
 No modification to be made without reference/approval from FM Approvals and BEKA Associates Design Department.

Notes:

- The associated intrinsically safe barriers and fieldbus power supply must be FM approved and the manufacturers' installation drawings shall be followed when installing this equipment.
 For installations in Canada the associated intrinsically safe barriers and fieldbus power supply must be CFM or CSA approved and the manufacturers' installation drawings shall be followed when installing the equipment.
- The unclassified location equipment connected to the associated intrinsically safe barriers and fieldbus power supply shall not use or generate more than 250V rms or 250V dc.
- Installation shall be in accordance with ANSI/ISA RP 12.06.01 "Installation of Intrinsically Safe Systems for Hazardous (Classified) Locations" and the National Electrical Code ANSI/NFPA 70.
 Installations in Canada shall be in accordance with the Canadian Electrical Code C22.2
- Fieldbus power supply with FISCO compliant output (IEC6009-27) or galvanic isolator with entity parameters complying with the following requirements:

U_o or V_t	equal to or less than	U_i
I_o or I_t	equal to or less than	I_i
P_o	equal to or less than	P_i
L_a	equal to or greater than	$L_{cable} + L_i$
C_a	equal to or greater than	$C_{cable} + C_i$

cont:

Title
 FM Approvals Control Drawing for Intrinsically Safe
 BA414DF & BA418CF Fieldbus Indicators

Drawn RC	Checked <i>[Signature]</i>	Scale NTS
Drawing No. Sheet 1 of 3		CI410-12

Iss.	1	2					
Date	28.03 2006	15.09 2009					
Modification	First release	Provision for alternative instrument titles added.					
Ckd.							
Appd.							
BEVA associates Hitchin England company confidential, copyright reserved.							
Iss.							
Date							
Modification							
Ckd.							
Appd.							

5. To maintain IP66 protection between the BA418CF and the mounting panel:
- Four panel mounting clips should be used
 - Minimum panel thickness should be
 - 2mm (0.08inches) Steel
 - 3mm (0.12inches) Aluminium
 - Outside panel finish should be smooth, free from particle inclusions, runs or build-up around cut-out.
 - Panel cut-out should be
 - 66.2 x 136.0mm -0.0 +0.5
 - (2.60 x 5.35 inches -0.00 +0.02)
 - Edges of panel cut-out should be deburred, and clean
 - Each panel mounting clip should be tightened to between:
 - 20 and 22cNm (1.77 to 1.95 inLb)

6. When installed in a hazardous (classified) location the BA414DF Fieldbus Indicators shall be fitted with cable glands / conduit hubs selected from the following table
- Metallic glands and hubs must be grounded – see note 7.

Class	Permitted gland or conduit hub
Class I	Any metallic or plastic cable gland or conduit hub that provides the required environmental protection.
Class II and III	<p>Crouse – Hinds Myler hubs SSTG-1 STG-1 STAG-1 MHUB-1</p> <p>O-Z / Gedrey Hubs CHMG-50DT</p> <p>REMKE hub WH-1-G</p> <p>Killark Glands CMCXAA050 MCR050 MCX050</p>

7. In addition to the supplied bonding plate, when 3 metallic glands or conduit hubs are fitted to a BA414DF Fieldbus Indicators, all metallic glands or conduit hubs must be connected together and grounded.
8. **CAUTION:** The BA414DF and BA418CF Fieldbus Indicator enclosures are manufactured from conductive plastic per Article 250 of the National Electrical Code the enclosures shall be grounded using the 'E' terminal on the terminal block.
9. The terminator on the Fieldbus must be FM or for Canadian installations CFM or CSA Approved.
10. The BA414DF and BA418CF should be mounted where they are shielded from direct sunlight.
11. The BA414DF may alternatively be titled:
 BA444DF Fieldbus Indicator
 BA444DL Fieldbus Listener
 BA424DF Fieldbus Set Point Station

cont:

Title		Drawn	Checked	Scale
FM Approvals Control Drawing for Intrinsically Safe BA414DF & BA418CF Fieldbus Indicators		RC		NTS
		Drawing No.	CI410-12	
		Sheet 2		

Iss.	Date	Modification	Ckd.	Appd.
1	28.03 2006	First release		
2	15.09 2009	Provision for alternative instrument titles added.		

BEKA associates
 Hitchin
 England
 company confidential, copyright reserved.

12. The BA418CF may alternatively be titled:
 BA448CF Fieldbus Indicator
 BA448CL Fieldbus Listener
 BA428CF Fieldbus Set Point Station

FISCO Rules

The FISCO Concept allows the interconnection of intrinsically safe apparatus to associated apparatus not specifically examined in such combination. The criterion for such interconnection is that the voltage (V_{max}), the current (I_{max}) and the power (P_{max}) which intrinsically safe apparatus can receive and remain intrinsically safe, considering faults, must be equal or greater than the voltage (U_0, V_{oc} or V_t), the current (I_0, I_{sc} or I_t) and the power (P_0) which can be provided by the associated apparatus (supply unit). In addition the maximum unprotected residual capacitance (C_i) and inductance (L_i) of each apparatus (other than terminators) connected to the Fieldbus must be less than or equal to 5nF and 10uH respectively.

In each I.S. Fieldbus segment only one active source, normally the associated apparatus, is allowed to provide the necessary power for the Fieldbus system. The allowed voltage (U_0, V_{oc} or V_t) of the associated apparatus used to supply the bus cable must be limited to the range 14Vdc to 24Vdc. All other equipment connected to the bus cable has to be passive, meaning that the apparatus is not allowed to provide energy to the system, except a leakage current of 50µA for each connected device. Separately powered equipment needs galvanic isolation to ensure the intrinsically safety Fieldbus circuit remains passive.

The cable used to interconnect the devices needs to comply with the following parameters:
 Loop resistance R': 15....150Ω/km
 Inductance per unit length L':0.4....1mH/km

Capacitance per unit length C': 80....200nF/km

$C' = C' \text{ line/line} + 0.5 C' \text{ line/screen}$, if both lines are floating

or

$C' = C' \text{ line/line} + C' \text{ line/screen}$, if the screen is connected to one line.

Length of spur cable: max. 30m

Length of trunk cable: max. 1km

Length of splice: max = 1m

Terminators

At the end of each trunk cable an FM Approved line terminator with the following parameters is suitable:

$R = 90 \dots 100 \Omega$

$C = 0 \dots 2.2 \mu F$

System evaluation

The number of passive devices like transmitters, actuators, connected to a single bus segment is not limited due to I.S. reasons. Furthermore, if the above rules are respected, the inductance and the capacitance of the cable need not be considered and will not impair the intrinsic safety of the installation.

Notes.

1. The intrinsic safety FISCO concept allows the interconnection of FM Approved Intrinsically Safe devices with FISCO parameters not specifically examined in combination as a system when:
 U_0 or V_{oc} or $V_t \leq V_{max}$, I_0, I_{sc} or $I_t \leq I_{max}$, $P_0 \leq P_i$.

For Canadian installations the intrinsic safety FISCO concept allows the interconnection of CFM or CSA Approved Intrinsically Safe devices with FISCO parameters not specifically examined in combination as a system when:

U_0 or V_{oc} or $V_t \leq V_{max}$, I_0, I_{sc} or $I_t \leq I_{max}$, $P_0 \leq P_i$.

Title

FM Approvals Control Drawing for Intrinsically Safe
 BA414DF & BA418CF Fieldbus Indicators

Drawn RC	Checked 	Scale NTS
Drawing No. Sheet 3		CI410-12

Appd.					
Ckd.					
Modification					
Date					
Iss.					
BEKA associates Hitchin England company confidential, copyright reserved.					
Appd.					
Ckd.					
Modification					
Date	28.03 2006	15.09 2009			
Iss.	1	2			

HAZARDOUS (CLASSIFIED) LOCATION

UNCLASSIFIED LOCATION

BA414DF LOCATIONS:
 Class I, Division 2, Groups A, B,C, D
 Class II, Division 2, Groups E, F & G
 Class III
 Class I, Zone 2, Groups IIC

BA418CF LOCATIONS:
 Class I, Division 2, Groups A, B,C, D
 Class I, Zone 2, Groups IIC

**BA414DF and BA418CF
 Maximum input and
 output parameters**

Terminals 1 & 2
 These terminals comply with
 The Fieldbus Nonincendive
 Concept (FNICO) defined by
 IEC60079-27
 (Typical current consumption
 13mA)

Vmax = 32V dc
 NIFW Vmax = 17.5V (FNICO)
 Ci = 0
 Li = 8µH

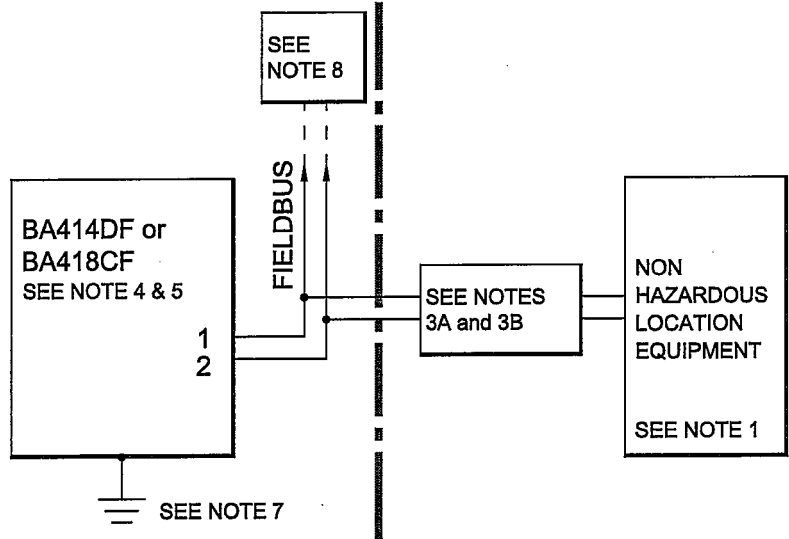

 Note:
 No modification to be made
 without reference/approval
 from FM Approvals and
 BEKA Associates Design
 Department.

Notes:

- The unclassified location equipment connected to the associated nonincendive field wiring apparatus must not use or generate more than 250V rms or 250V dc.
- Nonincendive field wiring installations shall be in accordance with the National Electrical Code ANSI/NFPA 70. The Nonincendive Field Wiring concept allows interconnection of Nonincendive Field Wiring Apparatus with Associated Nonincendive Field Wiring Apparatus using any of the wiring methods permitted for unclassified locations.
 Canadian installations shall be in accordance with the Canadian Electrical Code C22.2
- 3A. Linear power supply
 A linear fieldbus power supply shall be:
 FM Approved Associated Nonincendive Field Wiring Apparatus installed in the unclassified location with parameters complying with the following requirements:
 For Canadian Installations apparatus shall be CFM or CSA approved.
 OR
 FM Approved Nonincendive Field Wiring Apparatus installed in the classified location with parameters complying with the following requirements:
 For Canadian Installations apparatus shall be CFM or CSA approved.

Voc	equal to or less than	Vmax	
La	equal to or greater than	Lcable + Li	
Ca	equal to or greater than	Ccable	Cont.

Title		Drawn	Checked	Scale
FM Approvals Control Drawing for Nonincendive BA414DF & BA418CF Fieldbus Indicators		RC	<i>[Signature]</i>	NTS
		Drawing No.		CI410-13
		Sheet 1 of 4		

Iss.	Date	Modification	Ckd.	Appd.
1	28.03 2006	First release		
2	15.09 2009	Provision for alternative instrument titles added.		

BEKA associates
 Hitchin England
 company confidential, copyright reserved.

- 3B. FNICO non-linear power supply
 A FNICO non-linear fieldbus power supply shall be:
 FM Approved Associated Nonincendive Field Wiring Apparatus installed in the unclassified location complying with the following table:
 For Canadian Installations apparatus shall be CFM or CSA approved.
 OR
 FM Approved Nonincendive Field Wiring Apparatus installed in the classified location complying with the following table:
 For Canadian Installations apparatus shall be CFM or CSA approved.

Voc	Maximum current for Groups AB [IIC]	Maximum current for Groups CD [IIB, IIA]
V	mA	mA
14	274	570
15	199	531
16	154	432
17.5	121	360

4. To maintain IP66 protection between the BA418CF and the mounting panel:
 Four panel mounting clips should be used
 Minimum panel thickness should be 2mm (0.08inches) Steel
 3mm (0.12inches) Aluminium
 Outside panel finish should be smooth, free from particle inclusions, runs or build-up around cut-out.
 Panel cut-out should be 66.2 x 136.0mm -0.0 +0.5
 (2.60 x 5.35 inches -0.00 +0.02)
 Edges of panel cut-out should be deburred and clean
 Each panel mounting clip should be tightened to between: 20 and 22cNm (1.77 to 1.95 inLb)

Cont.

Date	28.03 2006	Title	Drawn	Checked	Scale
Iss.	1		RC		NTS
	2	FM Approvals Control Drawing for Nonincendive BA414DF & BA418CF Fieldbus Indicators	Drawing No.	CI410-13	
			Sheet 2		

Iss.	Date	Modification	Ckd.	Appd.
1	28.03 2006	First release		
2	15.09 2009	Provision for alternative instrument titles added.		

BEKA associates
Hitchin England
company confidential, copyright reserved.

5. When installed in a hazardous (classified) location the BA414DF Fieldbus Indicator shall be fitted with cable glands / conduit hubs selected from the following table.
Metallic glands and hubs must be grounded – see note 6.

Class	Permitted gland or conduit hub
Class I	Any metallic or plastic cable gland or conduit hub that provides the required environmental protection.
Class II and III	<p>Crouse – Hinds Myler hubs SSTG-1 STG-1 STAG-1 MHUB-1</p> <p>O-Z / Gedrey hub CHMG-50DT</p> <p>REMKE hub WH-1-G</p> <p>Killark Glands CMCXAA050 MCR050 MCX050</p>

6. In addition to the supplied bonding plate, when 3 metallic glands or conduit hubs are fitted to BA414DF Fieldbus Indicators, all metallic glands or conduit hubs must be connected together and grounded.
7. **CAUTION:** The BA414DF and BA418CF Fieldbus Indicator enclosures are manufactured from conductive plastic per Article 250 of the National Electrical Code the enclosures shall be grounded using the 'E' terminal on the terminal block.
8. The terminator on the Fieldbus must be FM Approved or for Canadian Installations CFM or CSA Approved
9. The BA414DF and the BA418CF should be mounted where they are shielded from direct sunlight.
10. The BA414DF may alternatively be titled:
BA444DF Fieldbus Indicator
BA444DL Fieldbus Listener
BA424DF Fieldbus Set Point Station
11. The BA418CF may alternatively be titled:
BA448CF Fieldbus Indicator
BA448CL Fieldbus Listener
BA428CF Fieldbus Set Point Station

Cont.

Date	28.03 2006	Modification	Ckd.	Appd.	Drawn	Checked	Scale
Iss.	1	First release			RC		NTS
	2	Provision for alternative instrument titles added.			Drawing No.	CI410-13	
Title					Sheet 3		
FM Approvals Control Drawing for Nonincendive BA414DF & BA418CF Fieldbus Indicators							

Iss.	Date	Modification	Ckd.	Appd.
1	28.03 2006	First release		
2	15.09 2009	Provision for alternative instrument titles added.		

BEKA associates
 Hitchin
 England
 company confidential, copyright reserved.

FNICO Rules

The FNICO Concept allows the interconnection of intrinsically safe apparatus to associated apparatus not specifically examined in such combination. The criterion for such interconnection is that the voltage (V_{max}), the current (I_{max}) and the power (P_{max}) which intrinsically safe apparatus can receive and remain intrinsically safe, considering faults, must be equal or greater than the voltage (U_o , V_{oc} or V_t), the current (I_o , I_{sc} or I_t) and the power (P_o) which can be provided by the associated apparatus (supply unit). In addition the maximum unprotected residual capacitance (C_i) and inductance (L_i) of each apparatus (other than terminators) connected to the Fieldbus must be less than or equal to 5nF and 20uH respectively.

In each I.S. Fieldbus segment only one active source, normally the associated apparatus, is allowed to provide the necessary power for the Fieldbus system. The allowed voltage (U_o , V_{oc} or V_t) of the associated apparatus used to supply the bus cable must be limited to the range 14Vdc to 17.5Vdc. All other equipment connected to the bus cable has to be passive, meaning that the apparatus is not allowed to provide energy to the system, except a leakage current of 50µA for each connected device. Separately powered equipment needs galvanic isolation to ensure the intrinsically safety Fieldbus circuit remains passive.

The cable used to interconnect the devices needs to comply with the following parameters:

Loop resistance R' : 15....150Ω/km

Inductance per unit length L' : 0.4....1mH/km

Capacitance per unit length C' : 80....200nF/km

$C' = C'$ line/line+0.5 C' line/screen, if both lines are floating

or

$C' = C'$ line/line + C' line/screen, if the screen is connected to one line.

Length of spur cable: max. 30m

Length of trunk cable: max. 1km

Length of splice: max = 1m

Terminators

At the end of each trunk cable an FM Approved line terminator with the following parameters is suitable:

$R = 90...100\Omega$

$C = 0....2.2\mu F$

System evaluation

The number of passive devices like transmitters, actuators, connected to a single bus segment is not limited due to nonincendive reasons. Furthermore, if the above rules are respected, the inductance and the capacitance of the cable need not be considered and will not impair the intrinsic safety of the installation.

Notes.

1. The FNICO concept allows the interconnection of FM Approved nonincendive devices with FNICO parameters not specifically examined in combination as a system when:
 U_o or V_{oc} or $V_t \leq V_{max}$.

For Canadian installations the FNICO concept allows the interconnection of CFM or CSA Approved nonincendive devices with FNICO parameters not specifically examined in combination as a system when:
 U_o or V_{oc} or $V_t \leq V_{max}$.

Title		Drawn	Checked	Scale
FM Approvals Control Drawing for Nonincendive BA414DF & BA418CF Fieldbus Indicators		RC		NTS
		Drawing No.	CI410-13	
		Sheet 4		